



Analysis of Semi-Bogie Based Propulsion System Used in Tehran Metro's trains in Degraded Mode of Operation

Mohammad Babaeyzadeh¹, Seyed Saeid Fazel^{2*}

¹School of Railway Engineering, Iran University of Science and Technology, Tehran, Iran

²Assistant Professor, Department of Control Engineering and Signaling, School of Railway Engineering, Iran University of Science and Technology, Tehran, Iran

ARTICLE INFO

Article history:

Received: (23.01.2021)

Accepted: 02.12.2021

Published: 05.12.2021

Keywords:

Propulsion system

Car-based

Bogie-based

Semi-bogie based

Degraded mode

RAMS

ABSTRACT

During the supply process of rolling stocks for metro systems, the propulsion system of trains in terms of separate power and control scheme should be selected based on the Reliability, availability, maintainability, and safety (RAMS) parameters along with some expected indexes in operation plan. This means that, in addition to undeniable control and operation advantages of a train that are equipped with the bogie-based propulsion system, the performance of the train is very important when an inverter module or each propulsion system's component fails, and therefore it should be considered to choose the propulsion system type. Now, a technical grading of propulsion system types can be made from the point of origin, which is a car-based type with the minimum advantages of operation, to the point of destination, which is a bogie-based type with the maximum advantages of operation. Therefore, the semi-bogie-based type that has been applied in Tehran metro trains with one common DC link, input protection circuit, and control is located in the middle of this grading. However, the definitions of the above-mentioned propulsion system types are presented at the beginning of this paper. In order to clarify the functional behavior of a semi-bogie-based type in a degraded and faulty mode of operation to determine its exact position in the above-mentioned grading between the first two types, some investigation will be done based on the simulation in MATLAB, and the results will be presented.

1. Introduction

In urban rail transportation systems such as heavy and light metro, monorail and tram, needed traction power to move the train is distributed in a number of cars, which forms up a combination of motorized and trailer cars as Fig.1.a [1] will be created in a train-set [2], [3] and [4]. On the other hand, in the structure of the last generation of metro trains equipped with three-phase induction motors, the propulsion system often includes a DC supply (either of the third-rail shoes or an overhead pantograph) and input filters, power distribution boxes, High-

speed circuit breaker, DC to AC converters such as traction converters and auxiliary loads converters, traction motors, train control and management system (TCMS), and communication links [1], [2] and [3]. Generally, these types of common propulsion systems are divided into a car-based type like in [2] and a bogie-based type like in [3] in terms of separation of power and control scheme. In the car-based type, according to Fig.1.b, one inverter module feeds all the traction motors of each motorized car. In the bogie-based type, according to Fig.1.d, there are two inverter modules in each motorized car that each feeds

*Corresponding author
Email address: fazel@iust.ac.ir

the traction motors of each bogie separately. In this case, each inverter module is equipped with one DC-link capacitor, one High-Speed Circuit Breaker (HSCB) as well as the switching control unit separately.

Meanwhile, the semi-bogie-based propulsion system type, as in [1], has a similar scheme to the bogie-based type according to Fig.1.c, which can be considered as an economic model. But in this case, both inverter modules are equipped with one common DC-link capacitor and one common HSCB, although the switching control unit can be applied for each module separately.

Finally, some parameters like supply costs, safety, and operation criterion affect the choice of the propulsion system of trains. However, it is clear that the performance of trains equipped with different types of propulsion systems are essentially the same in normal operating conditions, and in case of failure such as of critical system parts, the above-mentioned systems operate differently, and it affects RAMS parameters [4] and [5]. The case study in this paper is the semi-bogie-based type that has been designed by Bombardier in the trains of the last generation of the metro lines in Tehran [6].

2. Problem statement

Although based on the descriptions in the previous section-without any simulation, the performance of above mentioned three types of systems are clearly predictable in normal operation mode. However, the exact position of the semi-bogie-based system between the other two types in the above-mentioned grading causes buyers to make mistakes while choosing the type of system due to economic considerations. In fact, the problem arises when buyers see the difference between semi-bogie-based and bogie-based systems just in a DC link capacitor and an additional HSCB in the converter input, and so they mistakenly judge that the different performance of these two types is based on this small hardware difference.

To investigate this issue, the performance of three types of systems is considered in the two

main operation modes: normal and degraded. In the first case, the train is moved by traction power under normal operating conditions for all equipment of the propulsion systems, the performance of all three types of systems is completely identical because all the traction motors in each motorized car are fed, and therefore its analysis is ignored in this paper. But in the second case, the fundamental difference between the performance of the system will be evident, where at least one critical part of the system has been damaged and makes the operation of the propulsion system defective. Obviously, any defect that results in loss of an inverter module in each motorized car will result in traction motors power cut by related module, and therefore a percentage of total 'train's power will be lost according to the traction 'motors' power losses. This means that any defect that results in the loss of an inverter module in each motorized car will lead to the loss of the power of all the related motorized car in a train equipped with a car-based propulsion system type, and also half of the power of the related motorized car in a train equipped with a bogie-based propulsion system certainly. However, in the case of the semi-bogie-based type, the judgment is harder, and the simulations will determine the similarity of the dynamic behavior of this type of system during each possible fault to car-based or bogie-based type. The importance of this issue will become more significant where the operators prefer the semi-bogie-based to a full bogie-based type in order to save the cost, without taking into account the operational considerations and, in particular, considering the train availability as a part of the RAMS parameters.

Therefore, in this paper, by focusing on the behavior of a semi-bogie-based propulsion system which has been used in Tehran subway's trains, the performance of the system in the various conditions of probable faults is analyzed, and its exact position in the grading between two car-based and bogie base types of the propulsion system will be determined.

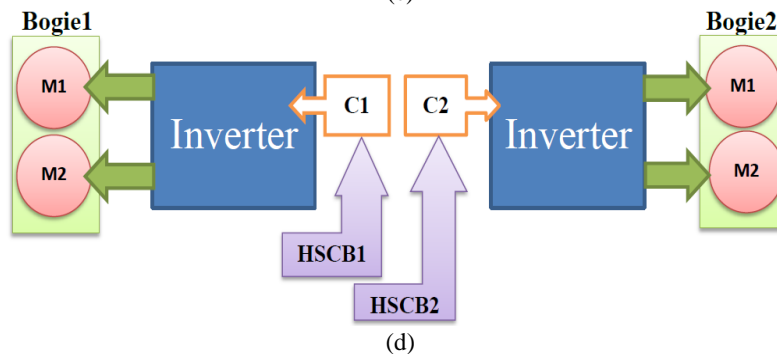
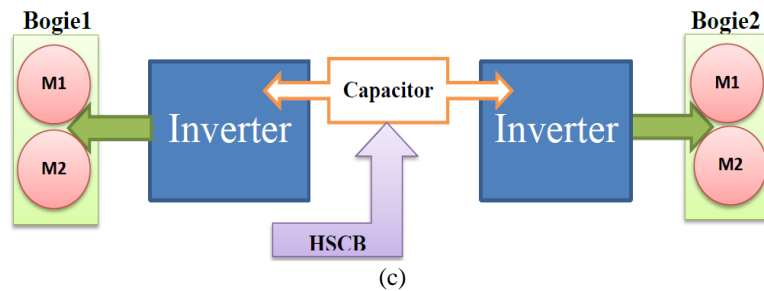
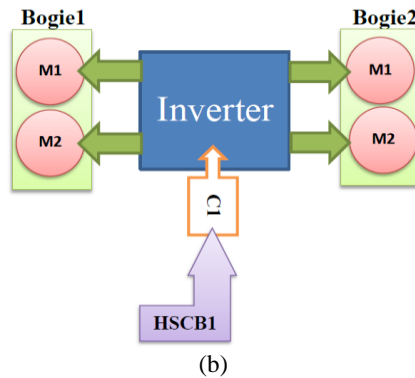
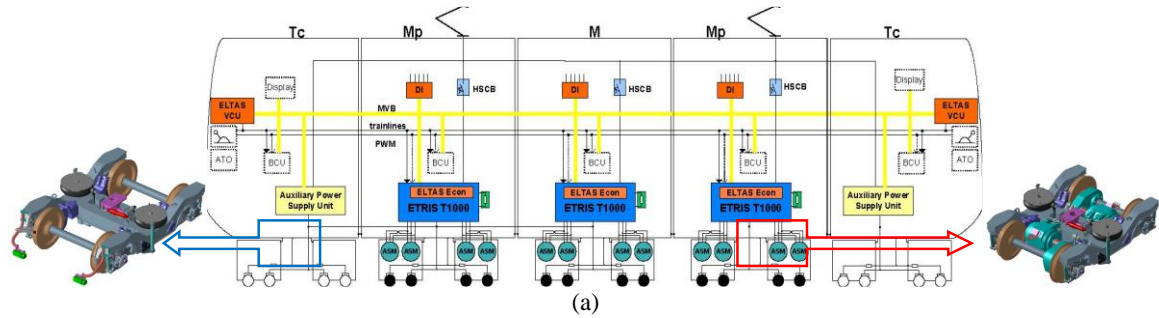

Fig.1a.a sample of design for one 5-car train-set including 3 motorized cars [1], b. car-based propulsion system type, c. semi-bogie-based propulsion system type, d. bogie-based propulsion system type

3. Definition of probable faults

Firstly, all possible faults in the degraded mode of a propulsion system should be defined and classified. It should be noted that some of these faults have a common effect on the performance of the system, and therefore, from the simulation point of view, they can be

grouped together in a common category. Table No.1 presents the division of common faults with the corresponding description. It is evident from the mentioned table that the faults which occurred in all three sides of AC, AC/DC, and DC of system, have a similar effect on the performance of the system in all three sections mainly. These faults have been divided in table

*Corresponding author
Email address: fazel@iust.ac.ir

No.1 with five A, B1, B2, C, D, and E codes based on their similar effects on the performance of the system.

After categorizing possible faults in the previous section, all thirteen errors can be subdivided into the following five basic groups for applying effects in simulations.

4. Simulations

Table No.1 - categorizing the possible faults

No.	Place	possible fault type	Equivalent fault in simulation
1	AC side (motors side)	Traction motor fault	A: 3-ph output line short circuit
2		Gearbox damage	
3		3-ph output line short circuit	
4	DC/AC side (inverter module)	Switch fault	B1: probable DC input line short circuit
5		Gate driver unit fault	
6		Interface units' fault	C: unsuitable performance of motors
7	DC side (line side)	Brake resistor's fault	D: loosing of safety and power losses
8		Brake 'resistors' switch's fault	
9		DC link capacitor fault	B1 or B2: probable DC input line short circuit or open circuit
10		Capacitor's charging circuit fault	B2: DC input line open circuit
11		DC input line short circuit	B1: DC input line short circuit
12		HSCB fault	E: isolating the converter by TCMS
13		Line inductor filter fault	

Note that when faults No. 7, 8, 12, and 13 happen, the safety in operation will be eliminated, and the TCMS stops operating immediately. Therefore, their simulation is ignored in this paper.

- 1. Three phases output short circuit with code A: Includes faults No. 1, 2, and 3 of table 1.
- 2. DC link short circuit with code B1: Includes faults No. 4, 5, 9, and 11 of Table 1
- 3. Open circuit in DC link with B2 code: Includes faults No. 9 and 10 of Table 1

- 4. Short circuit in switches with code B1 or C: Includes faults No. 4, 5, and 6 of table 1.
- 5. Open circuit in switches with codes B1 or C: Includes faults No. 4, 5, and 6 of table 1.

Currently, it is sufficient to apply the five above-mentioned conditions in the simulations. For this purpose, based on the structure of figure No.1.c, two three-phase 2-level H-bridge inverters equipped with IGBT switches have been simulated in the MATLAB-Simulink. The simulations have been done for a semi-bogie-based system with 750 V-DC input used in Tehran's subway's rolling stock. This system has

been designed by the Swedish Bombardier Company for Chinese CRC rolling stock manufacturers. The main parameters of simulation have been presented in table No.2 as

5. Simulation results

Finally, the simulation results are shown for the five categories listed in the previous section, respectively.

below. In all simulations, the curves will be simulated for $t=0-0.15s$ (7.5 cycles with $f=50Hz$), and each fault happens in $t=0.08s$.

Table No.2 – 'parameters' rates of simulation

No.	Section	Part	Descriptions
1	Stations	Traction Substation rectifier	3-phases diode based 750 V-DC
2	And Track	Third Rail Line	$R=1\text{ m ohm}$, $L=0.1\text{ mH}$
3		Track Rail	$R=1\text{ m ohm}$, $L=0.1\text{ mH}$
4	Train's Power Input	Line Inductor	$L=5\text{mH}$
5	Train's Propulsion System	DC-Link Capacitor	$C=20\text{mF}$
6		Inverter Modules	Two IGBT-VSIs in parallel
7		HSCB	Fault current setting: 4 kA
8	Traction load	Traction Motors	Loads: $P=4\times 200\text{kW}$, $PF=0.8$

In order to prevent the repetition of unimportant issues in this paper, all the related voltage and current curves are presented in Figs 2 to 7 only for the first category of faults. As shown in Fig 2, the HSCB trips after about two cycles because of the rising rate of fault current. It affects the curves for two cycles before HSCB tripping, and after that, the circuits will be cut totally. Figs 3 and 4 show the current curves of two faulty and non-faulty modules 3-phase outputs, respectively. The fault current flow between the two first phases is clear in these figs which its effect on input currents is shown in fig 5. With the same analysis, the output voltage curves of each inverter module have been presented in fig 6. In this case, there is no difference between curves of both faulty and non-faulty modules. Finally, fig 7 shows the current and voltage

curves of the traction substation rectifier separately. For other categories, only the indicative output curves will be shown in Figs 8 to 15.

Regarding figs 8 and 9, it is clear that the HSCB trips sooner (about one cycle) in comparison with the former type of fault because the fault current reaches 4kA as a setting point quicker. In fact, the short circuit happens in the common input of two modules, and therefore the length of the short circuit loop is shorter with lower resistance in ohm, which results in a higher fault rate. On the other hand, there is no difference between the current and voltage curves of the two modules because of the symmetrical location of the fault against the previous type of fault.

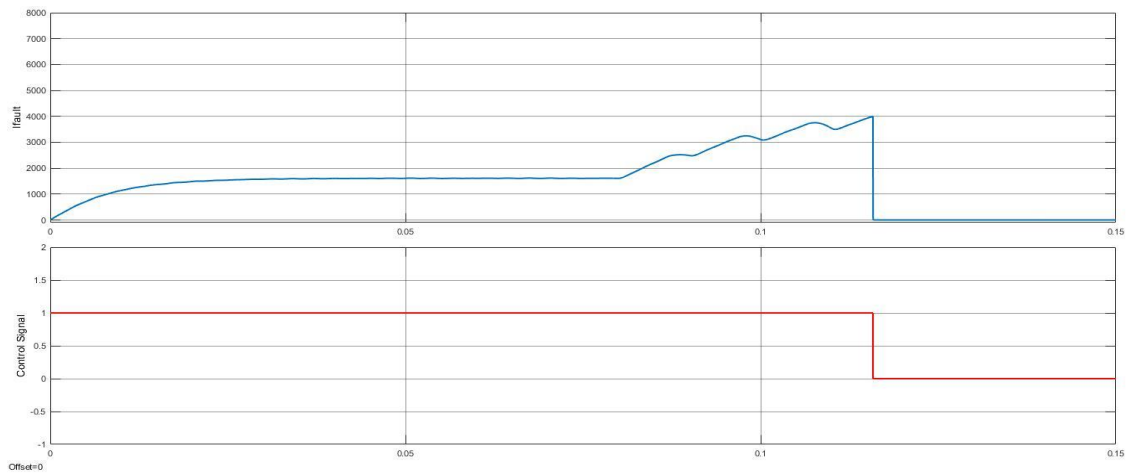

Fig 2. The fault current (up) and trip command signal by HSCB (low) for 3-ph output line short circuit

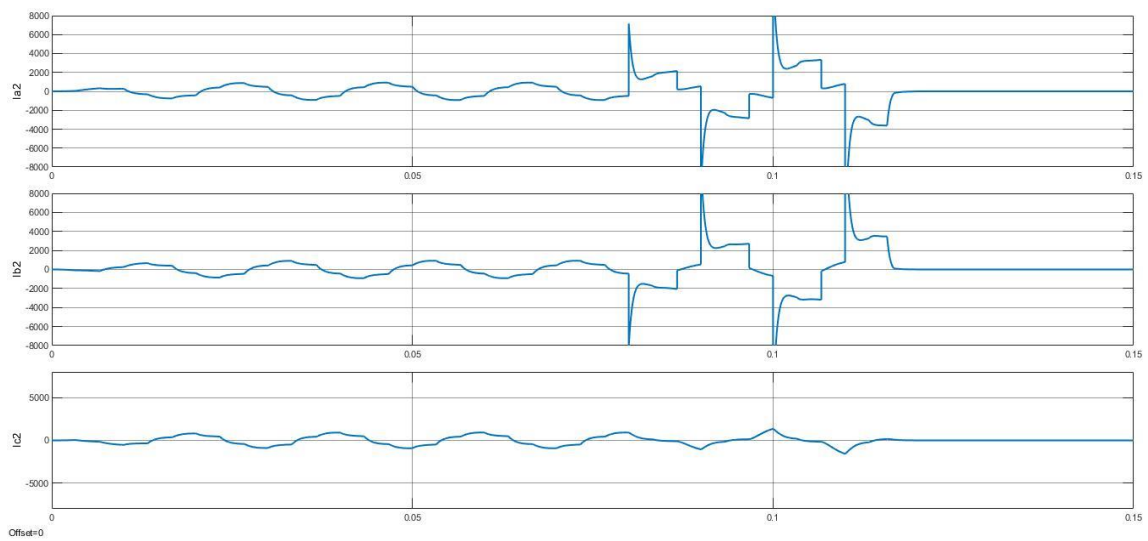

Fig 3. The output currents of faulty inverter module for 3-ph output line short circuit

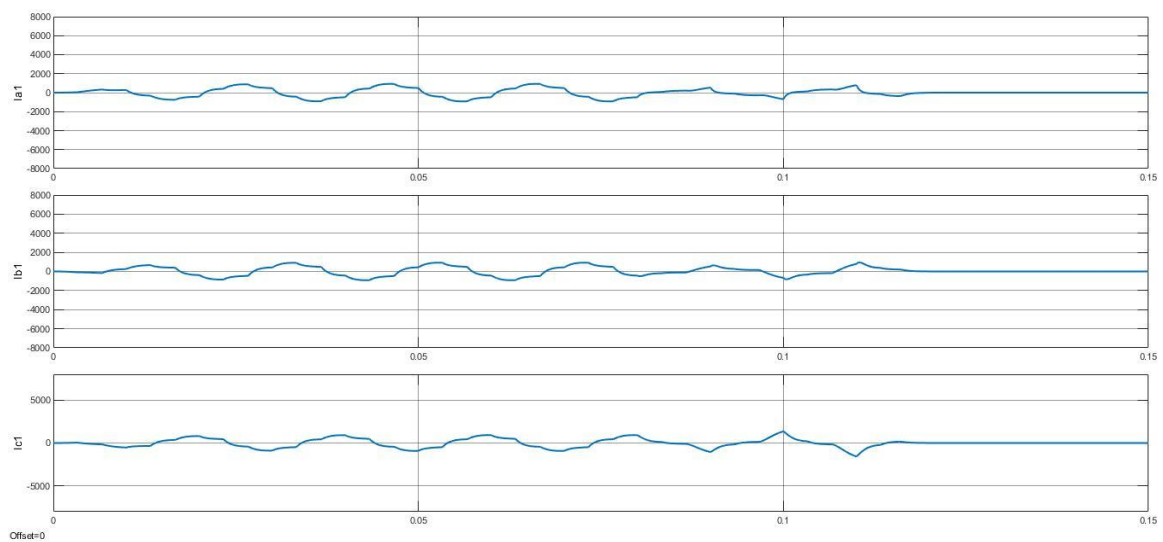

Fig 4. The output currents of non-faulty inverter module for 3-ph output line short circuit

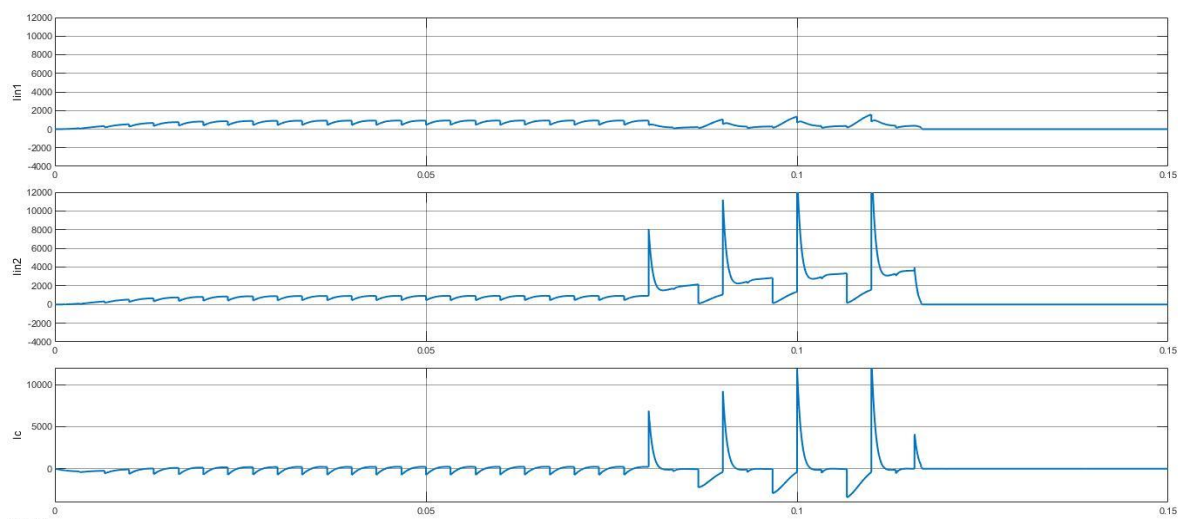

Fig 5. The input currents of the non-faulty inverter (up), faulty inverter (middle), and DC-link capacitor (low) for 3-ph output line short circuit

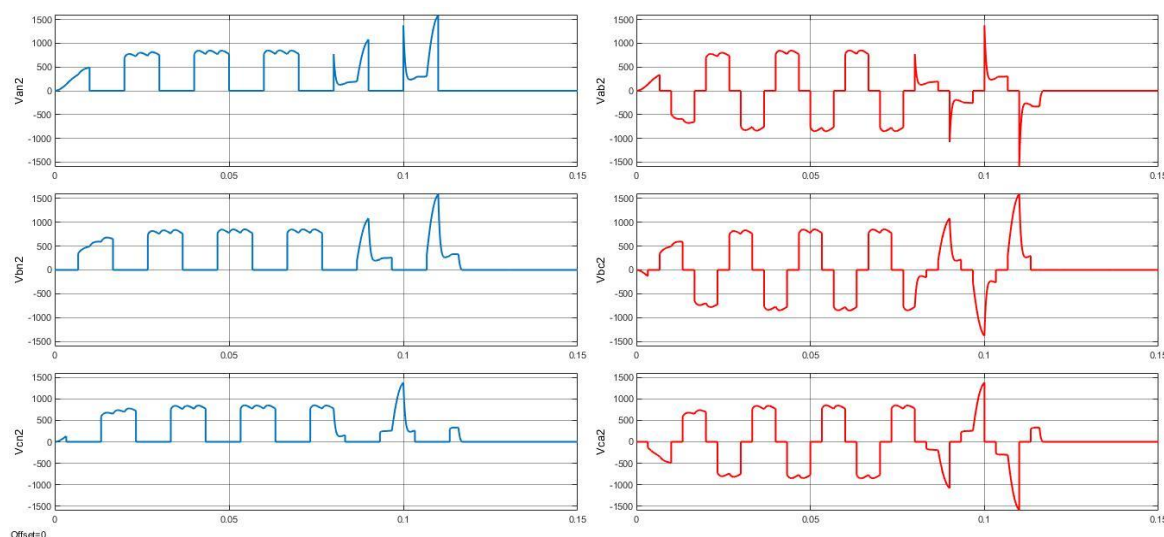

Fig 6. The output voltages of the faulty inverter (left: phase voltages, right: line voltages) for 3-ph output line short circuit

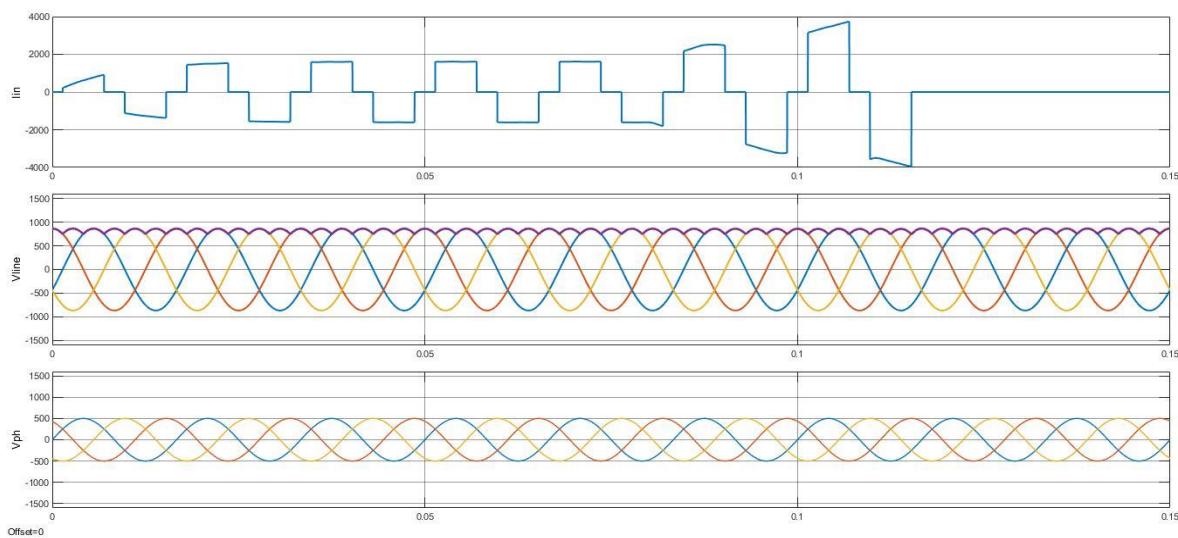

Fig 7. The output current and voltages of traction substation rectifier for 3-ph output line short circuit

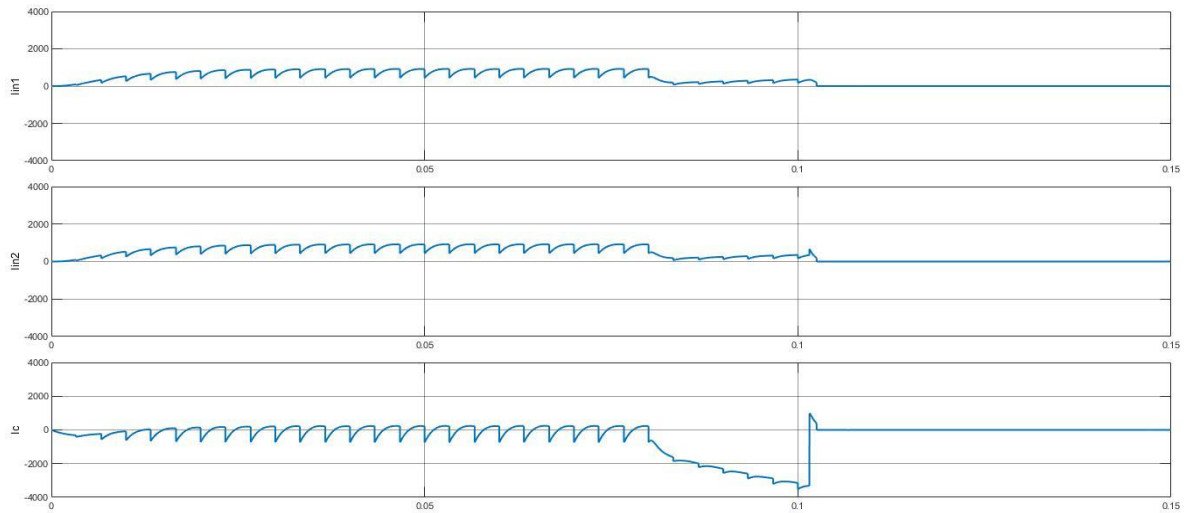

Fig 8. The input currents of 1st inverter module (up), 2nd inverter module (middle) and DC link capacitor (low) for DC link short circuit

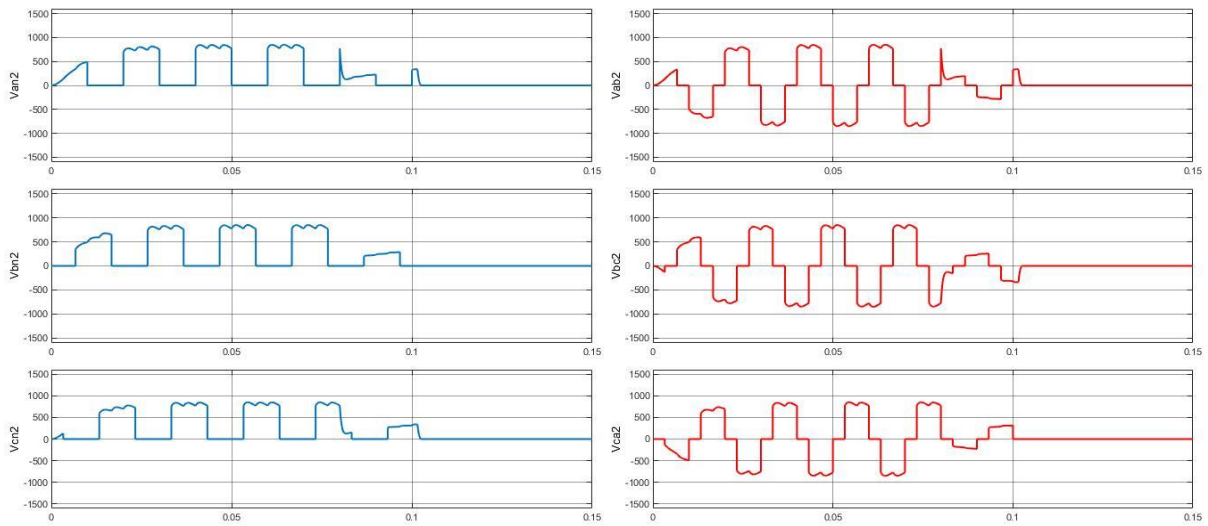

Fig 9. The output voltages of inverters (left: phase voltages, right: line voltages) for DC link short circuit

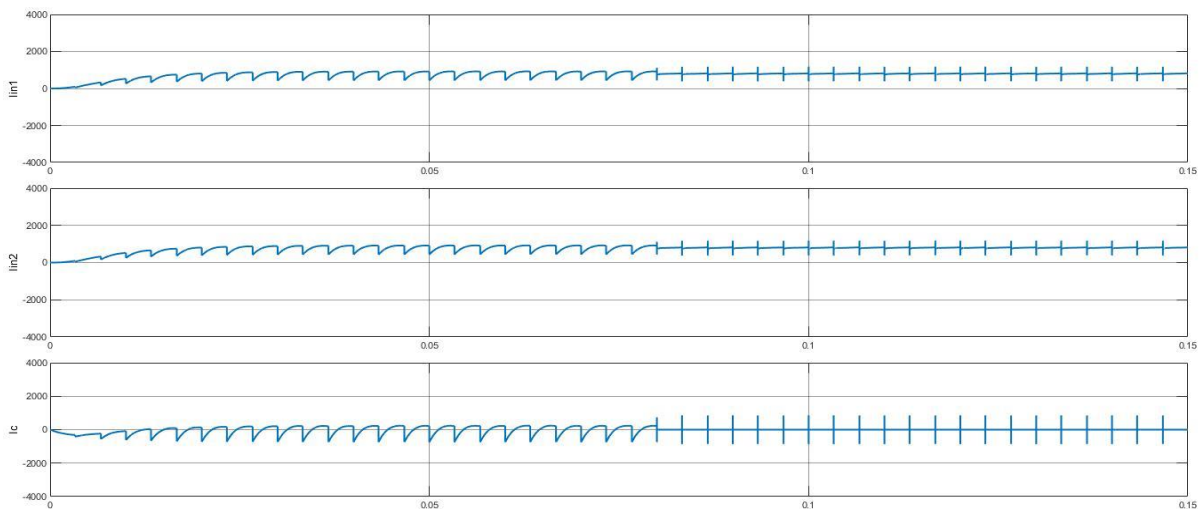

Fig 10. The input currents of 1st inverter (up), 2nd inverter (middle), and DC-link capacitor (low) for DC link open circuit

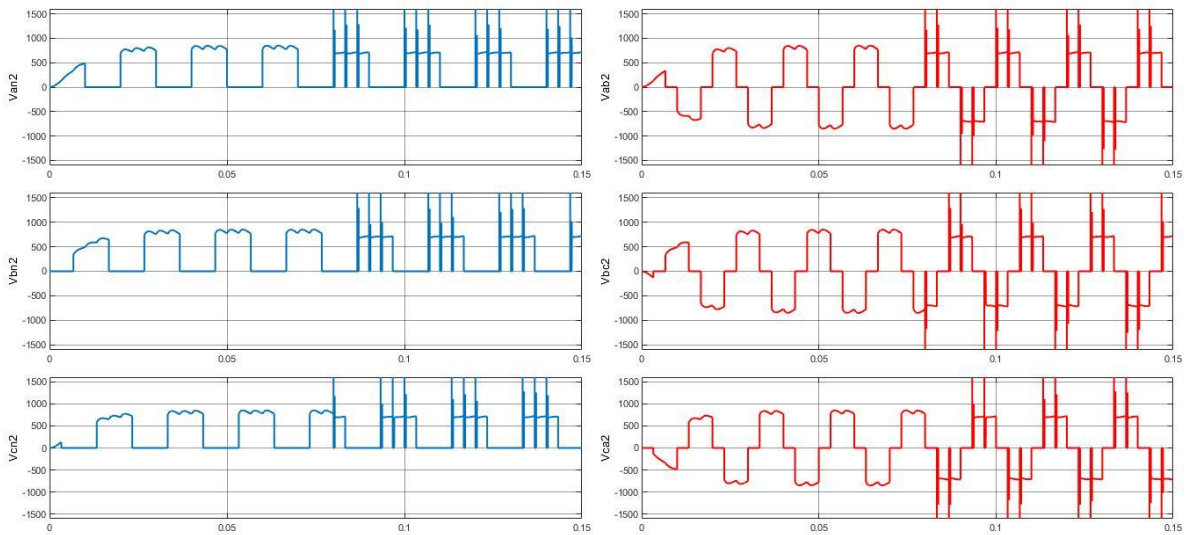

Fig 11. The output voltages of inverters (left: phase voltages, right: line voltages) for DC link open circuit

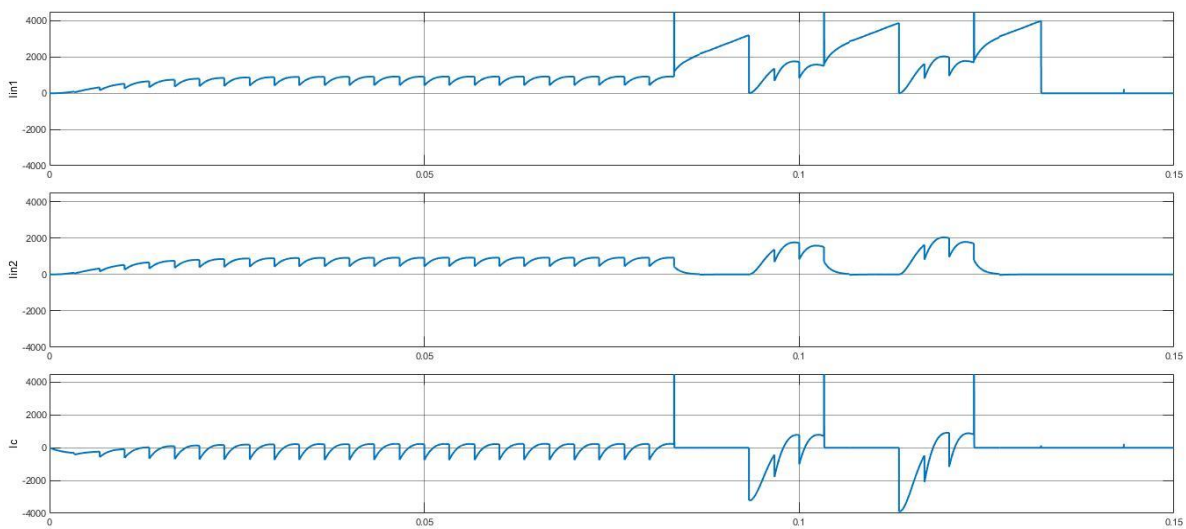

Fig 12. The input currents of faulty (up), non-faulty (middle) inverter, DC-link capacitor (low) for switches short circuit

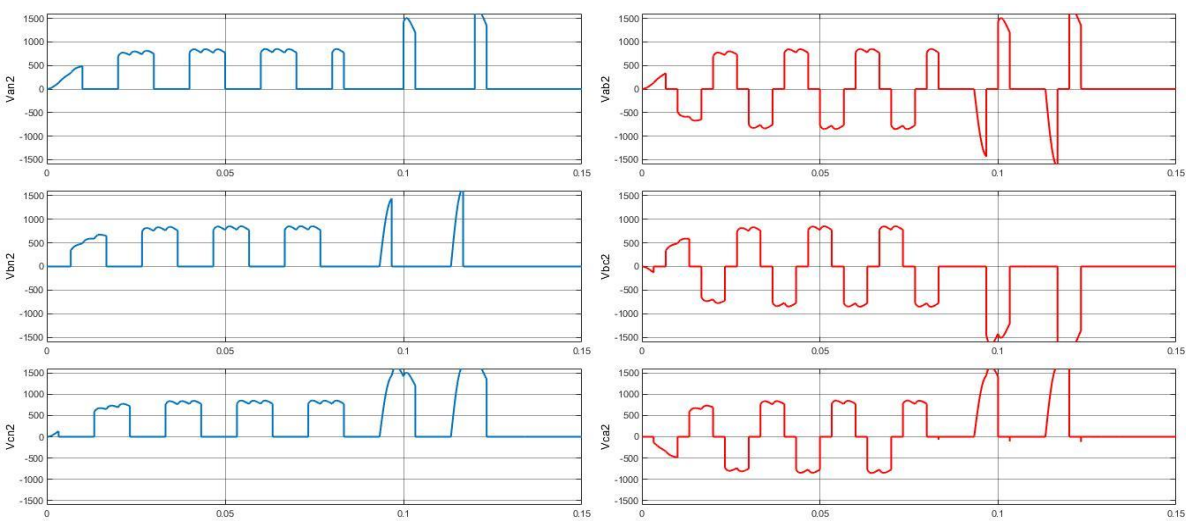

Fig 13. The output voltages of the faulty inverter (left: phase voltages, right: line voltages) for switches short circuit

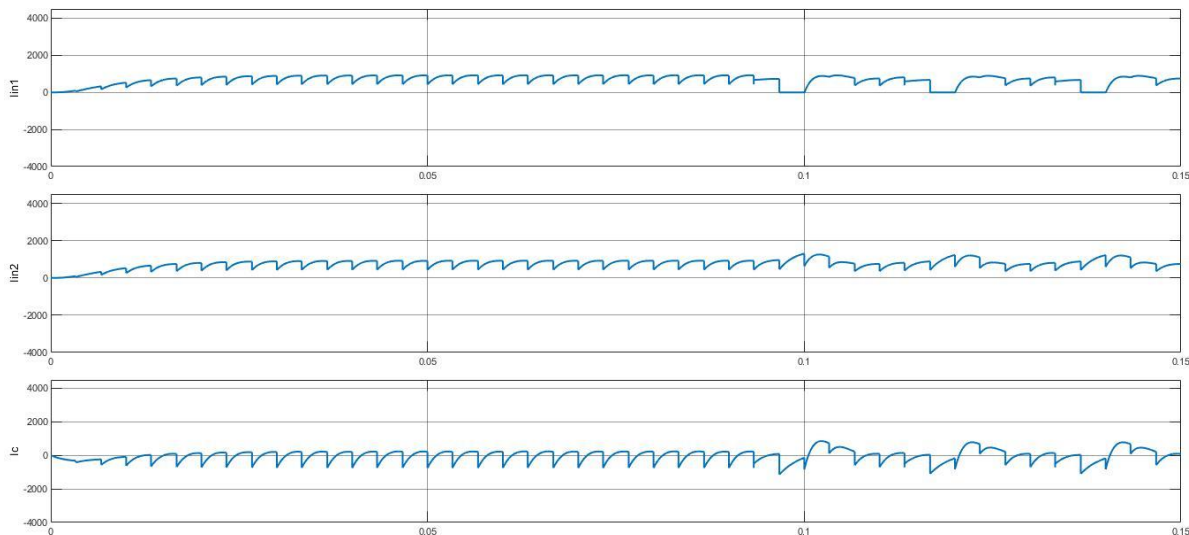

Fig 14. The input currents of faulty (up), non-faulty (middle) inverter, DC-link capacitor (low) for switches open circuit

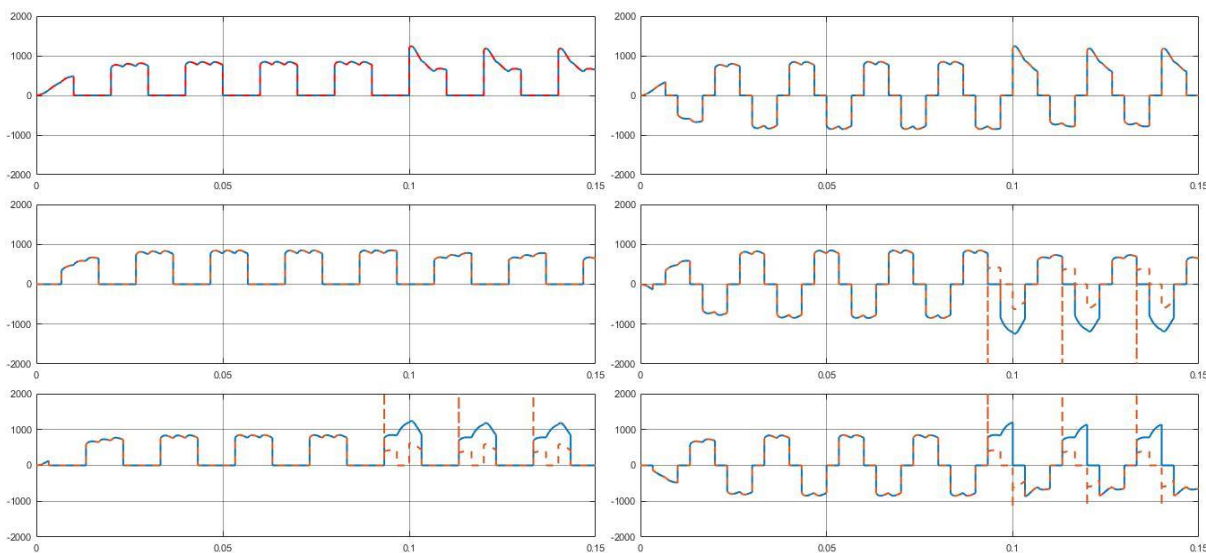

Fig 15. The output voltages of faulty(red) and non-faulty (blue) inverters for switches short circuit

Regarding figs 10 and 11, the issue is different. Because in the basis of the simulation process, the HSCB doesn't sense a high fault current and, therefore, will not trip circuits. In fact, the simulation has been done here in order to show the currents and voltages situation during the fault. But it should be noted that the HSCB trips from TCMS in this situation in an orderly manner practically due to keeping safe. Here, there is no difference between the current and voltage curves of the two modules because of the symmetrical location of the fault, the same as the DC-link short circuit type of fault.

Regarding figs 12 to 15, since the 'IGBT's could be a short circuit or open circuit in the faulty modes, two different probable situations can be observed. If the faulty IGBT becomes short circuit and another IGBT becomes "On" the relative leg of the inverter would be short circuit, and therefore the fault happens, which with the same analysis about figs 2 to 9, the HSCB trips after more than two cycles because of the rising rate of fault current. But, if faulty IGBT becomes an open circuit, regardless of another IGBT situation ("on" or "off"), the relative leg of the inverter cannot be short circuit and therefore, with the same analysis about figs 10 and 11, the HSCB 'doesn't trip due to fault current rate.

However, it should be noted that the HSCB trips in this situation practically by order from TCMS due to keeping safety, which has not been simulated in this paper.

Finally, it is clear from all simulation results that often, when a fault happens in a semi-bogie-based system, all the power of the related motorized car will be lost like a car-based system, and therefore it does not have the advantage of a bogie-based system. But, its difference with a car-based system appears after the initial corrective maintenance to eliminate the fault during operation or even partially isolate the defective part that causes half of the lost power capacity will be re-usable.

5. Conclusions

In this paper, the Bees algorithm was introduced for train trajectory optimization. BA was modified as NSBA for the first time to adapt to the multi-objective problem and enhance both global and local optimizations. The performance of the suggested networks was approved after early iterations and converged to the optimal solution. The results of the simulations showed that NSBA could solve the speed profile optimization problem with a wide range of costs. As future works for this study, considering the multiple train trajectory, optimizations, and comparison with other meta-heuristic algorithms is recommended.

Based on the simulation results and with emphasis on the absolute superiority of the bogie-based systems (regardless of price), this paper has focused on the presented semi-bogie-based system.

Therefore, the analysis of this system performance can be presented in the following two main stages, which their schematic process is shown in Fig 16, and the classification of results is done in Table 2 in detail:

1) At the moment of the fault occurrence: In all of the considered eleven faults, the simulated system has been similar to a car-based system.

This is due to the rapid operation of one HSCB, which is jointly applied for two inverter modules commonly.

2) After the initial corrective maintenance during operation: After the initial fault elimination, the simulated system performance depends on fault category and place. In fact, it still has been similar to a car-based system when the faults occur in the DC section of the system shown on the right column of table 3, due to rapid operation of one HSCB, which is jointly applied for two inverter modules commonly. It leads to the loss of all the power of the related motorized car. But it performs like a bogie-based system when the faults occur in two AC or DC/AC sections shown on the two left columns of table No.3 because the faulty inverter module can be isolated and switching commands be turned off by TCMS. In these cases, half of the power of the related motorized car returns to the train.

One point to consider for the above results is the importance of the speed of troubleshooting and maintenance operation on the calculations of RAMS parameters for the train. Because it shows that even it is possible to fix the defect or even isolate the defective part of the system in order to cause the above-simulated system keeps half of the power of related car similar to a full bogie-based system, but in cases where it is not possible to do maintenance until the train reaches the nearest station or depot, the semi-bogie-based system will play the role of a car-based system, and all the power of the related car will be out of reach. With these interpretations, taking into account the level of the parameters of the RAMS, especially the availability of the train relative to the small difference in the cost of the complete separation of the protection and the DC link of the two modules, the choice of a full bogie-based type of propulsion system against a semi-bogie-based type will be more than ever discussed. This will, in part, depend on the requirements and expectations of the operators.

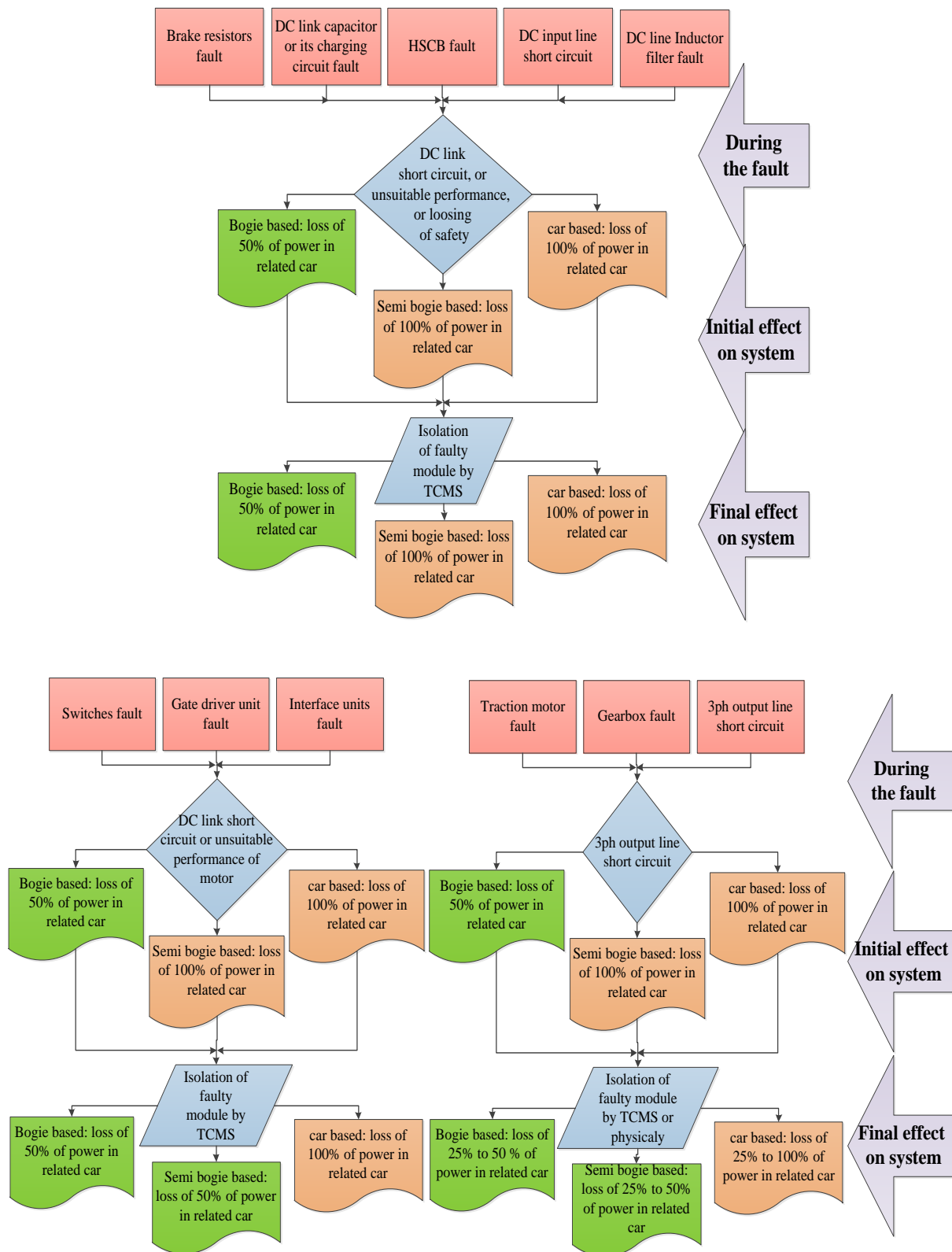

Fig 16. The diagram of faults occurring and corrective maintenance process in AC and DC/AC sides

Table 3-The performance of three types of propulsion system against faults situation in AC, DC/AC, and DC sides

		Equivalent fault In Simulation ↓	Car based		Semi bogie based		Bogie based	
			During	After maintenance	During	After maintenance	During	After maintenance
The rate of available power of the faulty motorized car (%) When a fault occurs in: →	Traction motors	3-ph output line short circuit	0	50-75	0	50-75	50	50-75
	Gearbox units		0	50-75	0	50-75	50	50-75
	3-phases output lines		0	0	0	50	50	50
	Gate driver units	DC input line short circuit or unsuitable performance of motors	0	0	0	50	50	50
	Interface units		0	0	0	50	50	50
	IGBT switches		0	0	0	50	50	50
	Brake resistors	DC input line short circuit, or unsuitable performance of the system, or losing of safety and power losses	0	0	0	0	50	50
	Charger circuits of capacitors		0	0	0	0	50	50
	DC link capacitors		0	0	0	0	50	50
	DC line inputs		0	0	0	0	50	50
DC line Inductor filters	0		0	0	0	50	50	

References

[1] [1]-Siemens Co".," Technical proposal of car-based Propulsion System - Contract of 315 cars for three cities in Iran", No.IRTCO-2008, Book 7, 2008.

[2]-BOMBARDIER Co. ", " Detailed Design of High voltage, semi bogie based propulsion, auxiliary and battery charging systems of 315 cars for three cities metro lines in Iran", No.IRTCO-2008, 3EST000228-3623, 2014.

[3]-CRRC Zhzhou Times Electric Co".," Technical proposal of bogie-based propulsion system –Contract of 630 cars project for Tehran metro lines", No.51067-2019, B33-9, 2017.

[4]-IEC, EN, UIC, Electrical Equipment Standards in Rolling Stock such as:" CECC.42000, EN 50124-1, EN 50155, EN 50207, JEC 60349-2 (1993), IEC 60310, IEC 60411-5".

[5]-EN50126:" " Railway Applications - the specification and demonstration of Reliability, Availability, Maintainability, and Safety." 1999

[6] BOMBARDIER Co. ", " Detailed Design of High voltage, semi bogie-based propulsion, auxiliary and battery charging systems of 455 metro cars project for Tehran metro lines", TUSRC-RS, Book 2, 2007.