



Sensitivity Analysis of Fastenings' Types on Track's Life-Cycle

Konstantinos Giannakos*

Civil Engineer, PhD, Fellow ASCE, M. TRB AR 050 & 060 Comm., AREMA, fib, Greece

ABSTRACT

During the study for the dimensioning as well as the selection of the individual materials constituting a railway track, the ballast and the substructure present residual deformations, directly related to the deterioration of the geometry of the track. The slighter the residual deformations and the slower their alteration over time is, the better the quality of the track. The actions acting on the track panel are almost proportionally dependent on the total track stiffness that is also influenced seriously by the fastenings' and total track's stiffness. This implies that the average stress on ballast underneath the sleepers' seating surface is also influenced by the stiffness. It is imperative to reduce as much as possible the average stresses at the sleepers' seating surface, by increasing track's stiffness. In the Greek network since the late 1980's up to 2000 an extended research program was performed due to cracks on twin-block concrete sleepers (over 60% on the total number laid on track). In the frame of this investigation, a new approach for the actions on sleepers and the ballast has been developed, by taking into account the real conditions of the line (maintenance etc.) which led to the increase of the demands in the specifications for the use of very resilient fastenings. In this paper a Sensitivity Analysis is attempted for different types of fastenings: rigid and resilient.

Keywords: Sleepers; dynamic loads; rigid/ resilient fastenings; actions/reactions; stiffness.

1. Introduction

Construction of a new line is expensive (10 - 25 Mio €/km) and in general can only be justified if the available capacity on the existing line has been exhausted and/or journey times are far from satisfactory. Competition from the road and air modes should also be taken into account. Where for quantitative and qualitative reasons a new line is not required, ways are often sought to bring about improvements at a low cost. The permissible speed and as a result the journey time of a train is contingent on: the vehicle design type, the type and length of train, the braking conditions, the line conditions, the operating conditions. When it comes

to line conditions, the curves and gradients as well as the constitutive elements of track are of decisive importance. A good track alignment should allow shorter journey times to be achieved and, with energy consumption and braking efficiency in mind, should keep breaks in speed to the strict minimum. In curves, the speed is determined in particular by: running conditions, lateral forces exerted on the track, stability of goods, comfort thresholds for passengers. The centrifugal/ centripetal force in the curves can be partially or wholly compensated by track cant. The profile of the track in principle does not require, or hardly requires, any special conditions to be satisfied other than the basic conditions to be fulfilled for conventional trains

* Corresponding Author
Email Address: k.giannakos@on.gr

operation. The actions acting on the track panel are almost proportionally dependent on the total track stiffness and consequently the average stress on ballast underneath the sleepers' seating surface. The ballast and the substructure are the elements of the track that develop residual deformations directly connected to the deterioration of the geometry of the track due to the average stress. The smaller the residual deformations and their increase over time, the better the quality of the track.

The AASHTO testing for road construction equation for maintenance costs is also applicable for a railway track [1]:

$$(Decrease\ in\ track\ geometry\ quality) = (increase\ in\ stress\ on\ the\ ballast\ bed)^m$$

where $m = 3$ to 4 .

The decrease in track geometry quality affects proportionally the maintenance costs according to the rule of the fourth power -10% higher stress, 51% greater annual maintenance cost- and it is related to the stresses on the ballast-bed and the degree of fouling of the ballast-bed. The latter influences the preservation of the track geometry. Since stress is equal to the ratio of the actions on the sleeper (reaction per "point") to the seating surface of the sleeper, and the seating surface of each sleeper type is standard, the estimation of the actions on the track

mainly dependent on the total track stiffness affected by the fastenings' stiffness is decisive for the deterioration of track's geometry.

In this paper an investigation is presented, using the four methods cited in international literature, on the improvement of track's life-cycle by the use of very resilient fastenings.

2. Layers of a Railway Track

2.1 Individual and Total Static Stiffness Coefficients

In Figure 1 left a cross section of a classic ballasted track is depicted with the terminology of layers as determined by U.I.C. [2]. A railway track structure can be modelled by a multi-layered structure of v layers simulated by a combination of springs (with coefficient ρ_i [kN/mm]) and dampers (with coefficients c_i). The static stiffness coefficient of the track is given by the following formula:

$$\rho_{total} = \frac{R}{z}$$

where R is the Reaction/ Action on each support point (sleeper) of the rail and z the correspondent deflection.

For the total track structure the following equation also applies:

$$\frac{1}{\rho_{total}} = \sum_{i=1}^v \frac{1}{\rho_i} = \frac{1}{\rho_{rail}} + \frac{1}{\rho_{pad}} + \frac{1}{\rho_{sleeper}} + \frac{1}{\rho_{ballast}} + \frac{1}{\rho_{substructure}} \quad (1)$$

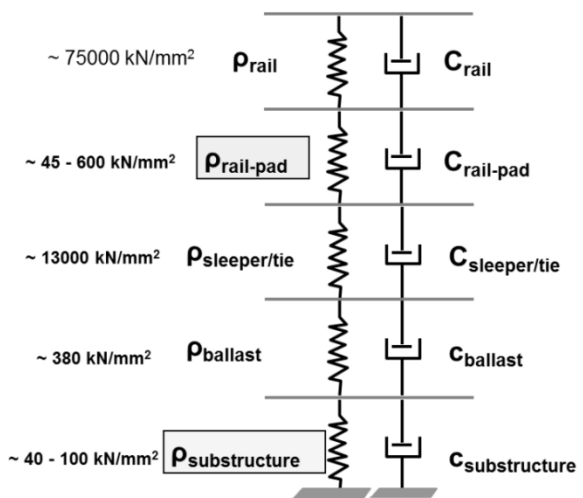
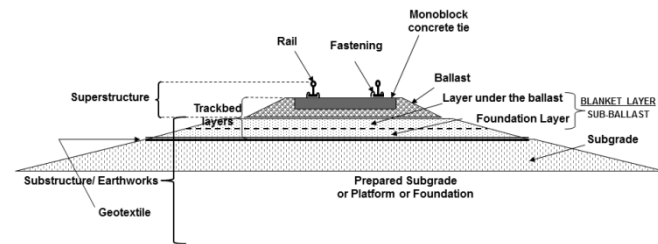

Figure 1. Cross section of a classic ballasted track (left) with the terminology according to the International Union of Railways [2] and schematic representation of the track as a combination of springs and dashpots (right)

where ρ_i is the coefficient of "Rail Support Modulus" [c in German literature and k in American] of each layer. This implies that ρ_{total} is a coefficient of quasi elasticity (stiffness) of the track, the equivalent of the "spring constant" in Hooke's law. It is defined as the "reaction coefficient of the sleeper", and ρ_i is the "spring constant" of each layer. In figure 1 right a simulation of the multi-layered structure "track" is depicted with the more characteristic values of ρ_i for the five main layers of the track. It is underlined that the pad's stiffness – from very stiff to very resilient fastening varies from 600 – 45 kN/mm. Three out of the five layers, namely the rail, the sleeper, and the ballast, contribute only 6 to 10% to the total track stiffness ρ_{total} . The total track stiffness is mainly affected by the static stiffness coefficients of the pad, ρ_{pad} , and of the substructure, $\rho_{substructure}$.

2.2 Loads and Actions/Reactions on Track according to the International Literature

The theoretical analysis is based mainly in Winkler's theory ([3]) of an infinite beam on elastic foundation. In international literature four methods are –mainly– cited.

Method cited in the American literature

This method is described in ([4], p. 247-273), in ([5], p. 16-10-26 to 16-10-32 and Chapter 30), in ([6], p.5.1-5.4 etc.) and it is based on the same theoretical analysis of continuous beam on elastic foundation. The dynamic load is dependent on an impact factor θ :

$$\theta = \frac{D_{33} \cdot V}{D_{wheel} \cdot 100}$$

The maximum Reaction/ Action R_{max} on each support point of the rail (sleeper)] is:

$$\begin{aligned} R_{max} &= p_{max} \cdot \ell = k \cdot w_{max} \cdot \ell = k \cdot y_{max} \cdot \ell = k \cdot \frac{\beta \cdot Q_{total} \cdot \ell}{2 \cdot k} \\ &= \sqrt[4]{\frac{\rho}{4EJ \ell}} \cdot \frac{Q_{total} \cdot \ell}{2} = \frac{1}{2\sqrt{2}} \cdot \sqrt[4]{\frac{\rho \cdot \ell^3}{EJ}} \cdot Q_{total} = \bar{A}_{stat} \cdot Q_{total} \end{aligned}$$

where: D_{33} in inches a wheel's diameter of 33 inches, D_{wheel} in inches the wheel's diameter of the vehicle examined, V the speed in miles/hour. The total load is:

$$Q_{total} = Q_{wheel} \cdot (1 + \theta)$$

The most adverse reaction/action on each support point (sleeper) is given by (see [7]):

$$R_{max} = \bar{A}_{stat} \cdot \left(1 + \frac{D_{33} \cdot V}{D_{wheel} \cdot 100} \right) \cdot Q_{wheel} \quad (2)$$

where: D_{33} in inches the diameter of a wheel of 33 inches, D_{wheel} in inches the wheel's diameter of the vehicle examined, V the speed in miles/hour, and \bar{A}_{stat} is the same as in equations of the European literature below and it is given by:

$$\bar{A}_{stat} = \frac{1}{2\sqrt{2}} \cdot \sqrt[4]{\frac{\ell^3 \cdot \rho_{total}}{E \cdot J}} \quad (3)$$

where: ρ_{total} the "rail support modulus" or "total track stiffness (static)" in kN/mm, ℓ the distance between the sleepers, E , J the modulus of elasticity and the moment of inertia of the rail.

Method cited in the German literature

In the German literature, the total load Q_{total} (static and dynamic) acting on the track, is equal to the static wheel load multiplied by a factor. After the total load is estimated, the reaction R acting on a sleeper, which is a percentage of the total load Q_{total} can be calculated ([8], [9]):

$$Q_{total} = Q_{wheel} \cdot (1 + t \cdot \bar{s})$$

where: Q_{wheel} is the static load of the wheel, and: (a) $\bar{s} = 0.1 \varphi$ for excellent track condition, (b) $\bar{s} = 0.2 \varphi$ for good track condition and (c) $\bar{s} = 0.3 \varphi$ for poor track condition, where: φ is determined by the following formulas as a function of the speed: (i) for $V < 60$ km/h then $\varphi = 1$ and (ii) for $60 < V < 200$ km/h then:

$$\varphi = 1 + \frac{V - 60}{140}$$

where V the maximum speed on a section of track and t coefficient dependent

on the probabilistic certainty P (t=1 for P=68.3%, t=2 for P=95.5% and t=3 for P=99.7%). The reaction R of each sleeper is calculated:

$$R = \frac{Q_{total} \cdot \ell}{2 \cdot L}$$

where: ℓ = distance between the sleepers, and:

$$L = \sqrt[4]{\frac{4 \cdot E \cdot J}{b \cdot C}}$$

where: C = ballast modulus [N/mm³] b= a width of conceptualized longitudinal support, that multiplied by ℓ equals to the loaded surface F of the seating surface of the sleeper. Consequently, in German literature the most adverse reaction R_{max} per sleeper is dependent upon the probability of occurrence and for 99.7% probability is given by:

$$R_{max} = Q_{wheel} \left(1 + 0.9 \cdot \left(1 + \frac{V - 60}{140} \right) \right) \cdot \bar{A}_{stat} \quad (4a)$$

for 200 km/h $\geq V \geq 60$ km/h, if $V < 60$ km/h then

$$R_{max} = 1.9 \cdot Q_{wheel} \cdot \bar{A}_{stat} \quad (4b)$$

for $V_{max} \leq 200$ km/h (124.30 mi/h), with probability of occurrence P=99.7%, where, Q_{wheel} = the static load of the wheel (half the axle load), \bar{A}_{stat} is calculated through equation (3). Prof. Eisenmann for speeds above 200 km/h proposed a reduced factor of dynamic component:

$$R_{max} = \left(1 + 0.9 \cdot \left(1 + \frac{V - 60}{380} \right) \right) \cdot \bar{A}_{stat} \cdot Q_{wheel} \quad (4c)$$

Equation (4c) leads to even greater under-estimation of the acting loads on track -than equation (4a)- with possible consequences to the dimensioning of track elements -like e.g. sleepers- as the literature describe, thus equation (4a) should be preferred for the sleepers' dimensioning.

Method cited in the French literature

There is also the method cited in French literature ([10], [11]) covering a probability of occurrence 95.5% and distributing the total acting

load with reaction per sleeper $1.35 \cdot \bar{A}_{stat} \cdot Q_{total}$ as follows:

$$R_{max} = \bar{A}_{stat} \cdot 1.35 \cdot \left[Q_{wheel} \cdot \left(1 + \frac{Q_{\alpha}}{Q_{wheel}} \right) + 2 \cdot \sqrt{\sigma(\Delta Q_{NSM})^2 + \sigma(\Delta Q_{SM})^2} \right] \quad (5)$$

where Q_{wheel} = the static wheel load, Q_{α} = the load due to cant deficiency, 2 coefficient of dynamic load for a 95.5 % probability of occurrence, $\sigma(\Delta R_{NSM})$ = the standard deviation of the dynamic load due to Non Suspended Masses, $\sigma(\Delta R_{SM})$ = the standard deviation of the dynamic load due to suspended masses.

The Giannakos (2004) method

Due to the lack of measurement data for the Greek network, a research program took place with the cooperation between scientific teams of engineers of the Greek and the National French Railways (SNCF) which resulted in proposing a new methodology, verifying both the data of the French and the Greek railway network. So for the influence of the Non-Suspended Masses and the Suspended Masses, as well as the standard deviation of the dynamic load, the following has been proposed theoretically and has been verified in practice ([1], [12], [17]). Experimental research and measurements have also been conducted in the laboratories of the Reinforced Concrete Department of the NTUA, the Geotechnical Engineering Department of the Aristotle University of Thessaloniki, the French Railways (SNCF), the Hellenic Ministry for the Environment, Physical Planning and Public Works/Central Public Works Laboratory, the sleeper factory of OSE, but also on track in the Athens-Thessaloniki axis ([12]). Based on: (a) the situation observed and recorded by the research conducted on the Greek railway network, (b) the available data from measurements at foreign networks, and (c) published research data and after an -over 15 years- investigation program, in the Greek network, due to the appearance of extensive cracks in concrete sleepers laid on track, in a percentage over 60%, the author developed a method that is able to predict the observed conditions on track ([1], [12]). The actions on track

panel are calculated through the following equation covering a probability of occurrence 99.7%:

$$R_{\max} = (Q_{\text{wheel}} + Q_{\alpha}) \cdot \bar{A}_{\text{dyn}} + 3 \cdot \sqrt{\sigma(\Delta R_{\text{NSM}})^2 + \sigma(\Delta R_{\text{SM}})^2} \quad (6a)$$

where Q_{wheel} = the static wheel load, Q_{α} = the load due to cant deficiency, \bar{A}_{dyn} = dynamic coefficient of sleeper's reaction, 3 coefficient of dynamic load for a 99.7 % probability of occurrence, $\sigma(\Delta R_{\text{NSM}})$ = the standard deviation of the dynamic load due to Non Suspended Masses of the vehicle, $\sigma(\Delta R_{\text{SM}})$ = the standard deviation of the dynamic load due to Suspended Masses of the vehicle (for details the interested reader should read [12]) and :

$$\bar{A}_{\text{dynam}} = \frac{1}{2 \cdot \sqrt{2}} \cdot \sqrt[4]{\frac{\ell^3 \cdot h_{\text{TR}}}{E \cdot J}} \quad (7)$$

where h_{TR} the total dynamic stiffness of the track given by:

$$h_{\text{TR}} = \frac{1}{2 \cdot \sqrt{2}} \cdot \sqrt[4]{E \cdot J \cdot \frac{\rho_{\text{total}}}{\ell}} \quad (8)$$

In the motion of the Non Suspended Masses (NSM) of the vehicle a section of track is also participating. For an accurate calculation of this track mass m_{TRACK} -participating in the motion of the m_{NSM} - a detailed theoretical analysis compared to data from measurements is cited in [13], [14].

The equation (6a) is transformed in:

$$R_{\max} = \frac{1}{2 \cdot \sqrt{2}} \cdot \sqrt[4]{\left(\frac{\rho_{\text{total}} \cdot \ell^3}{E \cdot J}\right)^3} \cdot (Q_{\text{wheel}} + Q_{\alpha}) + (3 \cdot \underbrace{\sqrt{k_{\alpha} \cdot V \cdot \sqrt[8]{2^6 \cdot (m_{\text{NSM-vehicle}} + m_{\text{TRACK}})^4 \cdot E \cdot J \cdot \left(\frac{\rho_{\text{total}}}{\ell}\right)^3}}_{\sigma(\Delta R_{\text{NSM}})}} + \underbrace{\left(\frac{V - 40}{1000} \cdot N_L \cdot Q_{\text{wheel}}\right)^2}_{\sigma(\Delta R_{\text{SM}})}) \quad (6b)$$

In all the theoretical methods above the total static stiffness of track plays a key role: the more elastic the track is, the less the sleepers are stressed. It is therefore evident that resilient fastenings play a key role in the distribution of loads on track, and eventually in the life-cycle of the track. More analytic description of the calculation of the dynamic component of the Load due to the

undulatory wear of the rail see [15] and due to an isolated defect see [16].

2.3 Sensitivity Analysis for two Types of Fastenings in the Greek network

Introducing the two different fastening systems W14 and RN and their mechanical properties

The RN and W14 fastening systems are doubly elastic fastenings, presenting resiliency in the vertical direction both upwards and downwards, due to the two “springs”: the “spring” of the clip and the “spring” of the pad. To calculate the real acting forces on the superstructure and the sleepers, applying the aforementioned equations, in a multi-layered construction with poly-parametrical function, the exact rigidity of the elastic pad of the fastening for each combination of parameters must be determined. In the case of the RN fastening a tie-pad stiffness of the 4.5 mm thick pad must be used, according to its load-deflection curve (Appendix 1, Figure A1-1, right). The most adverse curve is used because it describes the behavior of the pad during the approach of the wheel since the second curve describes the unloading of the pad after the passage of the wheel. The stiffness of the substructure varies from 40 kN/mm for pebbly substructure to 250 kN/mm, for rocky tunnel bottom with insufficient ballast thickness. Each time this stiffness changes in the equations above, the “acting” stiffness of the tie-pad also changes.

So the method –included in the regulations- for

calculating the pad stiffness from two discrete values (i.e. 18 and 70 kN) of load is not describing the real situation, where an equilibrium among the various “springs” that comprise the multilayered system of the track takes place. The trial-and-error method must be utilized in order to more accurately estimate the stiffness of the pad in each case (of pad type).

In this paper the stiffness of the pad is calculated with the trial-and-error method and in a subsequent step the forces-loads acting on the twin-block sleepers with the RN fastenings are calculated. The same procedure is followed for the Sk1-14 tension clamp of the W14 fastening with the very resilient, "soft", Zw700 pad. The load-deflection curve of the pad Zw700 of the W14 fastening is depicted in Appendix 1, Figure A1-1, left. The results of the calculations are compared with the real situation of the track in the Greek network, where the twin-block concrete sleepers presented extended cracking, having exceeded the cracking and failure thresholds [12]. This comparison is done for any type of concrete sleeper equipped with the W14 Fastening. The calculations were performed for the U2/U3 twin-block concrete sleeper equipped with W14 Fastenings. However the resulting actions are the same as in the case of any monoblock concrete sleeper (e.g. B70) equipped with W14 Fastening, which has not presented up to now any cracking at all.

Evaluation of the methods in a case study of the Greek network

The results of Giannakos (2004) method are in agreement with observations on tracks under operation (a detailed description in [12] and [17]).

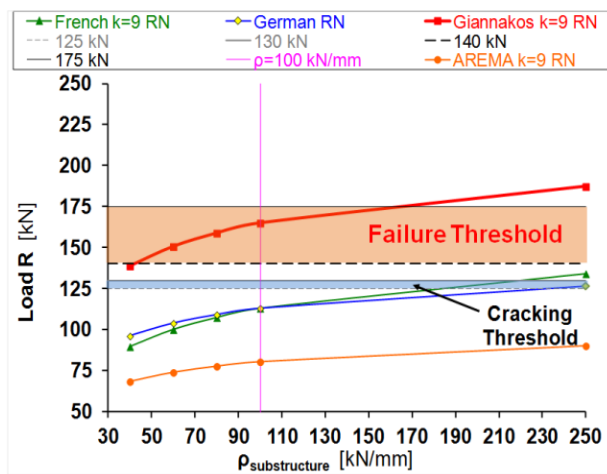

Figure 2a. Calculation of actions on U2/U3 twin-block sleepers with RN fastenings (4.5 mm pad) with the method: (a) cited in French literature (Eqn 5), (b) cited in German literature (Eqn 4), (c) cited in American literature (Eqn 2) and (d) Giannakos -2004- (Eqn 6)

After an over ten-years research program -under the guidance of the author- in the Greek Railway network (with the participation of the research department "Voie"/ Track of the French Railways, of the subsidiary of Belgian Railways -Transurb Consult- and Universities of Greece -NTUA, AUT- Austria -Graz- etc.) to investigate the causes of the appearance of extensive cracking in concrete sleepers of French technology U2/ U3 type (over 60% up to 80% of the total number laid on track) the Giannakos method was developed

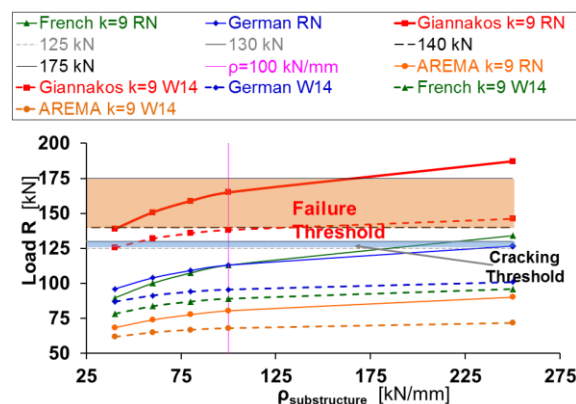

Figure 2b. Calculation of actions on U2/U3 twin-block sleepers with W14 and RN fastenings (4.5 mm pad) with the method: (a) cited in French literature (Eqn 5), (b) cited in German literature (Eqn 4), (c) cited in American literature (Eqn 2) and (d) Giannakos -2004- (Eqn 6)

The laboratory tests showed -beyond any doubt- that the cracked sleepers in Greek network, were produced in full compliance with the existed prescriptions and technical specifications of the time. Moreover the sleepers' samples -chosen randomly from the track- presented strength values in laboratory tests higher than the prescribed in the specifications. The cracking was not a result of defective manufacture of the original sleepers or of no compliance with the specifications. The values of actions derived when applying the formulas cited in the American, German and French literature, under the most adverse conditions, are lower than the limits of the regulations, fact justifying sporadic appearance of cracks (in the order of 1-2%) but not at all their systematic appearance at 60% of the sleepers (and even more) for a characteristic stiffness $\rho_{\text{substructure}}=100\text{kN/mm}$, in the Greek railway network at the 1980-2000s. If we apply W14 fastenings no cracking at all is expected. The results in summary are depicted in Fig. 2a for RN

Fastening and Fig. 2b for W14 Fastening (for a detailed description see [12] and [1]).

Estimation of the Actions for different combinations of sleepers and rigid or resilient fastenings

In the Greek network three types of sleepers are used with different types of fastenings (rigid or resilient) and different types of pads

1- Wooden sleepers

With K fastening, scheduled in Germany on 1925 (see [18]) and at this era with plywood pads and now with EVA pads of approximately 450-600 kN/mm stiffness. In Greece in the 1970s -after the adoption of RN fastening in concrete sleepers (twin-block U2, U3) with 4.5 mm pads, these pads were laid with K fastening also. The research program led to the conclusion that it was not an appropriate combination due to the very low toe-load (see [1]). In the 1990s the EVA pad was adopted either in K original fastening or with Skl-12 ([1]). In this paper these two combinations are used.

2- Steel sleepers with (in the same logic) 4.5 mm pad in the beginning and then with EVA pads in the original rigid clips or afterwards with Skl-ET ([1]). In this paper these two combinations are used.

3- Concrete sleepers: (a) twin-block concrete sleepers U2, U3 with RN fastening and 4.5 mm pad (of medium stiffness), (b) twin-block concrete sleepers U31 with Nabla fastening (resilient) and (c) Monoblock sleepers of prestressed concrete B70 with W14 fastening (resilient) either with Zw700 pad of Wirtwein or Zw700 pad of Saargummi, with two different stiffness coefficients. In this paper these three combinations are used plus one more - not existing in Greece- the concrete sleeper with EVA pad (and Skl-1) that was investigated at the past.

The calculations of the actions/reactions per sleeper have been performed by the four aforementioned methods. In Figure 3 the results of the method cited in German literature are depicted.

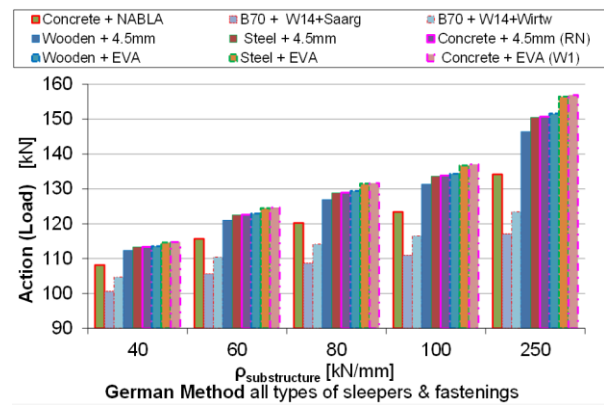

Figure 3. Actions on sleepers according to the method cited in German literature (Eqn4)

In Figure 4 the results of the method cited in French literature are depicted and in Figure 5 the results of the method cited in American literature are depicted. In Figure 6 the results of the Giannakos (2004) method are depicted.

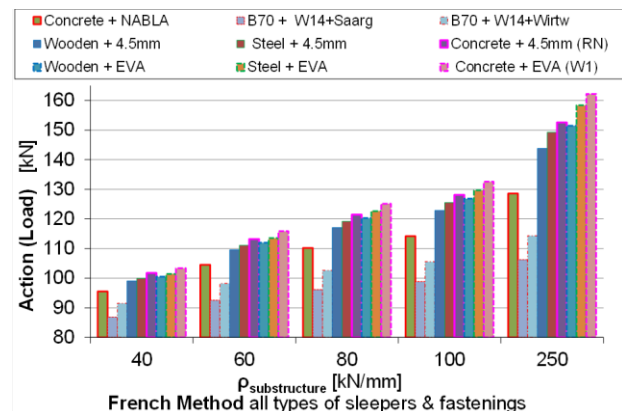

Figure 4. Actions on sleepers according to the method cited in French literature (Eqn5)

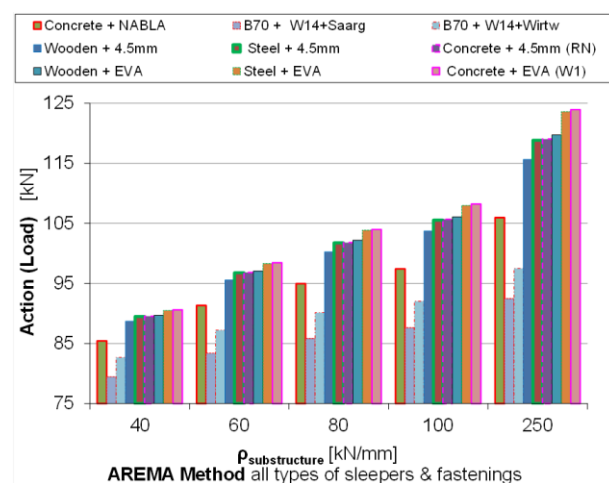

Figure 5. Actions on sleepers according to the method cited in American literature (Eqn2)

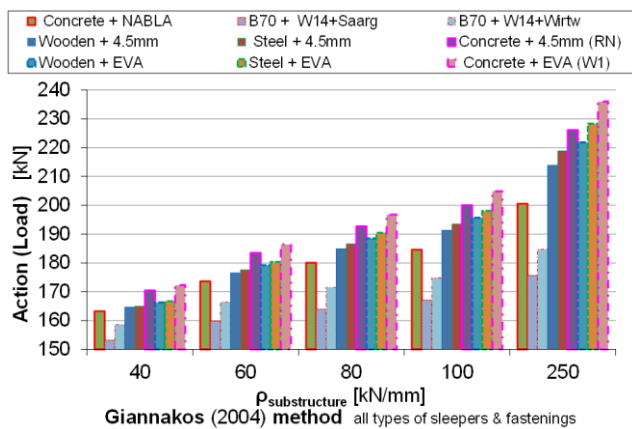

Figure 6. Actions on sleepers according to the Giannakos (2004) method (Eqn6)

In the above cases the calculations have been performed for $V=200\text{km/h}$, axle load 22.5 t, rail UIC60, $\ell=60\text{cm}$, cant deficiency 160mm, height of the vehicle's centre of gravity from rail running surface 1.5m, Non-Suspended Masses 1.5t, average condition of rail running table ($k=9$) and $D_{\text{wheel}}=33.86\text{inch}$. In this study the steel sleeper, the wooden sleeper with 4.5mm pad as well as the concrete sleeper with RN fastening were evaluated even if it is almost prohibitive to be used in lines with $V_{\text{max}}=200\text{ km/h}$.

2.4 Sensitivity Analysis of the Influence of Fastenings + Sleepers on Life-Cycle of Track

Regarding the issue of ballast fatigue, the existing literature assumes a uniform distribution of stresses under the sleeper and without further details uses the mean value of pressure. Based on research performed by the International Union of Railways (U.I.C.) –with the participation of principal European Railway Networks- the maximum moment measured actually on track results from parabolic stress distribution ([19]). But in reality, the seating of the sleepers is supported on discrete points, the points of contact with the grains of the ballast ([20]), and the resulting necessity to calculate the stress per grain of ballast cannot give results that are comparable with the existing literature.

So it is possible to use the mean value of pressure not as an absolute quantity, but comparatively, *as an evaluation criterion*, and in combination with the

possibility it covers ([20]). The mean stress is estimated by dividing the action by the seating surface of the semi-sleeper. For the same seating surface –as in the case of each sleeper- the action on each sleeper is the decisive factor. Finally it is not the sleeper's material but the total stiffness of the track ρ_{total} –modulated mainly by the fastening and substructure in a percentage of 84-90%- that plays the key role for the magnitude of the actions on track panel and, consequently, for the magnitude of the mean stress on the ballast-bed. Experiments performed by ORE ([21], [22]) showed that sleepers made of different materials (wood, concrete) exhibit almost identical values of track settlement. ORE/UIC was the main international railway research body for decades performing the experiments in many European Railway Networks such as the French, the German, the Polish, the British etc, with the participation of these networks. From Figures 3 through 6 the lower magnitude of actions occur for B70+W14+Zw700 Saargummi pad and the higher magnitude for wooden sleeper+EVA pad or steel sleeper+EVA pad. More analytically, for the most characteristic value of $\rho_{\text{substructure}}=100\text{kN/mm}$ the difference from the higher to the lower actions is as follows:

1- for the German method the steel sleeper+EVA pad gives 23.2% higher and the wooden+EVA 21% (the same percentage for concrete+EVA also)

2- for the French method the steel sleeper+EVA pad gives 31.2% higher, the wooden 28.4% and the concrete+EVA 34.1%.

3- for the American method the steel sleeper+EVA pad gives 23.5% higher (the same percentage for concrete+EVA also) and the wooden+EVA 21 %, and 4.- for the Giannakos (2004) method the concrete+EVA pad gives 22.6% higher, the concrete+RN 19.7%, the steel sleeper+EVA pad gives 18.6% and the wooden+EVA 17.1 %.

4- for the Giannakos (2004) method the concrete+EVA pad gives 22.6% higher, the concrete+RN 19.7%, the steel sleeper+EVA pad gives 18.6% and the wooden+EVA 17.1 %.

The seating surface of B70 is considered to be 100%, the seating surface for the wooden sleeper is 96.5% (smaller), the steel sleeper 97.1%, the twin-block U31 69.2%, and the U2/U3 is 65.2%, meaning that the stress is higher. It has to be underlined that even the same combination of sleeper type (monoblock B70 of prestressed concrete) with fastening type (W14) but with different pads (Zw700 Wirtwein or Zw700 Saargummi) gives different values of actions on track panel (and mean stresses on ballast-bed) fluctuating (a) from 4.1-5.4% for the German method, (b) from 5.3-6.3% for the French method, (c) from 4.1-5.4% for the AREMA method and (d) from 3.5-5.2% for the Giannakos (2004) method for a relevant variation of psubstructure between 40kN/mm for pebbly substructure to 250 kN/mm for rocky bottom in tunnels with small depth of ballast. This difference is sufficiently high to secure more adverse performance in tracks with relatively more "rigid" pad according to the AASHTO testing for road construction equation for maintenance costs (Giannakos, 2004, 2010a, 2011):

(Decrease in track geometry quality) = (increase in stress on the ballast bed)^m

where $m = 3$ to 4 , implying that a 10% higher stress on ballast-bed provokes 33.1-46.4% higher annual maintenance cost for the track.

For 20% to 30% as above the increase in maintenance cost could even reach 285%. The Life-Cycle of the track -dependent upon the fatigue of the repetitive loading- is highly influenced by the action and stress reduction. It is evident that the influence of the fastening's static stiffness coefficient on the total static stiffness coefficient of the track is $67\% \times 90\% \approx 58\%$. Consequently, we could approach the influence of the rigidity of the fastening on the Track's Life-cycle as the 58% of the aforementioned estimations in the present paragraph.

3. Conclusions

In modern railway infrastructure fastenings of high-resilience significantly reduce the actions on the concrete sleepers and track superstructure, as well as the mean stress on ballast-bed compared to the stiffer fastenings. Therefore their use should be of utmost importance in the modern railway tracks

since they eliminate the problems created by the loading of the track superstructure and substructure. The fastening and substructure stiffness contributes over 85% to the total static stiffness coefficient and the final values of actions/reactions. The increase of the actions on the track ballast-bed (and consequently to the stresses) –due to the use of stiff or rigid fastenings in comparison to the very resilient ones- varies from 19% to 34 % depending on the calculation method and affects significantly the annual maintenance cost according to the AASHTO road test that can almost triple in some cases. The Life-Cycle of the track is dependent upon the fatigue of the repetitive loading which –in turn– is highly influenced by the action and stress reduction. The static stiffness coefficient of the fastening contributes in the total static stiffness coefficient of the track approximately for 58% and consequently in the Life-cycle of the track in a relevant percentage of the calculated above numbers.

References

- [1] K. Giannakos, Actions on Railway Track, Papazissis publications, Athens, English edition, (Greek edition 2002), 2004, www.papazisi.gr
- [2] U.I.C. (International Union of Railways), Code 719R/1-1-1994, Earthworks and track-bed layers for railway lines, 1994.
- [3] E. Winkler, Die Lehre von der Elastizität und Festigkeit (The Theory of Elasticity and Stiffness), H. Dominicus, Prague, 1867.
- [4] W. Hay, Railroad Engineering, John Wiley & Sons, 1982.
- [5] AREMA, Manual for Railway Engineering, 2012.
- [6] E. Selig, J. Waters, Track Geotechnology and Substructure Management, Thomas Telford, 1994 reprinted 2000.
- [7] K. Giannakos, Heavy Haul Railway Track Maintenance and Use of Resilient versus Stiff Fastenings, TRR 2261, (2011) 155-162.
- [8] J. Eisenmann, The Rail as support and Roadway, theoretical principles and practical examples, in *Railroad Track - Theory and Practice*, edited by Fastenrath Fritz, Frederic Ungar Pub.Co., New York, part 2, 1981.
- [9] J. Eisenmann, Die Schiene als Tragbalken, Eisenbahningenieur 5, (2004).
- [10] J. Alias, La voie ferree, IIème edition, Eyrolles, Paris, 1984.
- [11] A. Prud' homme, J. Eriau, Les nouvelles traverses en beton de la SNCF, RGCF-2, 1976.
- [12] K. Giannakos, A. Loizos, Evaluation of actions on concrete sleepers as design loads–Influence of fastenings,

International Journal of Pavement Engineering (IJPE) 11 (3), (2010) 197 – 213.

- [13] K. Giannakos, Theoretical calculation of the track-mass in the motion of unsprung masses in relation to track dynamic stiffness and damping, International Journal of Pavement Engineering (IJPE), Special Rail Issue High-Speed Railway Infrastructure: Recent Developments and Performance, 11 (4), (2010) 319-330.
- [14] K. Giannakos, Influence of the Track's Damping on the Track Mass Participating in the Motion of the Non Suspended Masses of Railway Vehicles - Theoretical Calculation and Comparison to Measurements, volume published in honor of professor G. Giannopoulos, Aristotle University of Thessaloniki, 2012.
- [15] K. Giannakos, Track Defects and the Dynamic Loads due to Non-Suspended Masses of Railway Vehicles, International Journal of Mechanics, 7 (3), (2013) 180-191.
- [16] K. Giannakos, Actions on a Railway Track, due to an Isolated Defect, International Journal of Control and Automation (IJCA), 7 (3), (2014) 195-212.
- [17] K. Giannakos, Loads on track, Ballast Fouling and Life-cycle under Dynamic Loading in Railways, Journal of Transportation Engineering, ASCE, 136 (12), (2010) 1075-1084.
- [18] G. Schramm, Permanent Way Technique and Permanent Way Economy, Otto Elsner Verlag, Darmstadt, Germany, 1961.
- [19] ORE (Office de Recherches et d'Essais de l' U.I.C.), Question D71, Rp9, Sollicitation de la voie, du ballast et de la plateforme sous l' action des charges roulantes - Sollicitations des traverses en beton, Utrecht, Octobre, 1969.
- [20] J. Eisenmann, G. Kaess, Das Verhalten des Schotters unter Belastung, *ETR* (29) 3, Darmstadt, 1980.
- [21] ORE (Office de Recherches et d'Essais de l' U.I.C.), Question D117, Rp2, Optimum Adaptation of the Conventional Track to Future Traffic - Study of the change in the track level as a function of the traffic and of the track components. (First results of laboratory and site tests), April, 1973.
- [22] ORE (Office de Recherches et d'Essais de l' U.I.C.), Question D117, Rp4, Optimum Adaptation of the Conventional Track to Future Traffic - Rheological Properties of the Track, April, 1974.
- [23] U.I.C. (Union International des Chemins de Fer), fiche UIC (Code) 864-5/01-01-86, Specification technique pour la fourniture de semelles a poser sous rails, 4e edition, 1986.

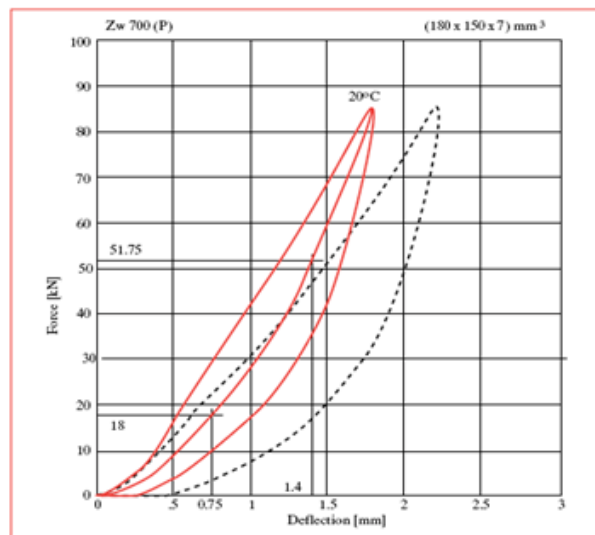

Load-deflection diagram of elastic pad Zw 700 (P) for 20°C

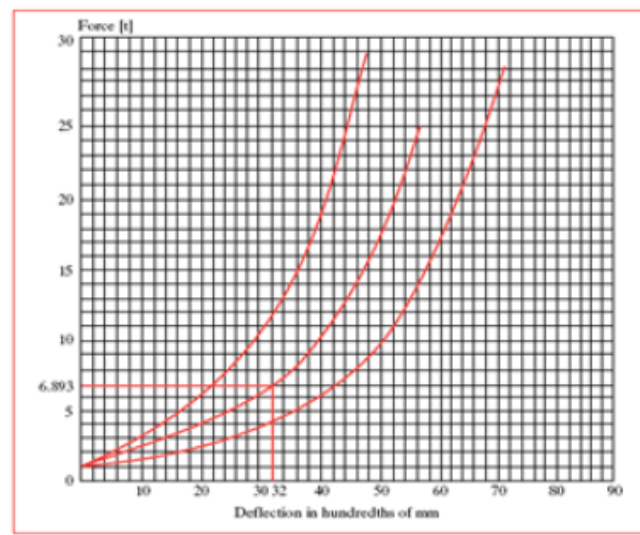

Deformations in hundredths of mm of the 4.5mm elastic pad (RN fastening)

Figure A1-1. Load – Deflection curves (up) of the pad Zw700 of the fastening W14 of VFS ([1]) and (down) of the pad of 4.5 mm of the RN fastening ([23])