



Crashworthiness Analysis and Energy Absorption Enhancement of a Passenger Rail Vehicle

H. Molatefi^{1*}, M. Azizi², H. Mozafari³

¹School of Railway Engineering, Iran University of Science and Technology, Narmak, Tehran, Iran

²Center of Excellence in Railway Transportation, Iran University of Science and Technology, Narmak, Tehran, Iran

³Department of Mechanical & Materials Engineering, University of Nebraska-Lincoln, W342 NH, Lincoln, NE 68588-0526, USA

ARTICLE INFO	ABSTRACT
<p>Article history: Received: 16 Apr. 2016 Accepted: 27 Jun. 2016 Published: 21 Aug. 2016</p> <hr/> <p>Keywords: Crash worthiness Carbody Rail vehicle EN15227 Finite element method</p>	<p>Interests in increasing the trains' speed of travel, generated higher degrees of wariness about the possible sever accidents. Since, the passenger wagon car body needs to be a safe compartment for its occupants therefore; great attention should be paid on its design. In this study, a passenger car body that is originally made in Eastern Germany and its chassis are modeled to simulate the crash analysis according to EN 15227 standard. The results are then used in order to optimize the wagon chassis design. This investigation is performed in two steps. In the first step, which consists of simulation of the original wagon model, it is found that due to the lack of efficiency in crash force absorbent, some modifications in the design are needed. In the second step, the original chassis is modified and by implementing honeycomb cores as energy absorbing devices, higher energy absorption is achieved. Furthermore, impact stresses in mid-section of the chassis considerably decreased. The proposed energy absorbing device can be implemented in the front end of the chassis to provide a crashworthy structure. The results show that by modifying the under-frame the amount of energy absorption is increased by 46%, and also, the amount of maximum stress in the center of the under-frame is reduced by 66%.</p>

1. Introduction

The tendency for increasing the trains' speed of travel is followed by the great attention of researchers. Derailment, over-turn, direct and incline train collision are the most catastrophic events in railway transportation which are classified in crashworthy analyses. Hence, safety of rail vehicles confronted to these accidents is vital and urgent in design plans.

Nowadays, heavier traffic and higher speed of rail vehicles obliged engineers to be more cautious about safety concepts. Lewis et al. carried out crush

tests and developed a finite element model to predict crashworthy behavior of the rail vehicle [1]. Cleon studied crashworthiness of TGV trains [2]. Mayvill et al. developed the coach car crush zone [3]. Chirwa classified crashworthiness concepts in rail vehicles in which considered new design parameters [4]. Smith studied the crashworthiness of trains on the basis of background principles [5]. Leutenegger et al. developed a lightweight structure to meet tougher crashworthiness standards [6]. Lewis et al. investigated of a collision between an IC255 train and a car in details [7]. Walter studied a new European standard of crashworthiness of rail

*Corresponding Author

Email Address: molatefi@iust.ac.ir

http://tlx.doi.org/.....

vehicles and the effects on safe trains [8]. Jacobsen et al. conducted a full-scale test on a passenger rail train and established the degree of enhanced performance of alternative design strategies for the passenger rail car crashworthiness [9]. Spirk et al. discussed the design of a deformable obstacle to be used in simulated rail and road collisions as prescribed by scenario 3 specified by standard EN 15227 [10]. Carolan et al. examined the effectiveness of one particular crash energy management (CEM) system design for passenger rail cars [11]. The intention was to determine what modifications to the components could improve the crashworthiness of passenger rail car beyond the baseline CEM design without introducing new hazards to the passengers. O'Neill and Carruthers described the conceptual design and analysis of a lightweight energy absorber for rail vehicles which meets the level crossing impact requirements outlined in European crashworthiness standards [12]. Tyrell et al. conducted six tests to measure the crashworthiness performance of existing equipment and to measure the performance of equipment incorporating CEM features [13]. The collision scenario addressed by these tests in a cab car-led passenger train colliding with a conventional locomotive-led passenger train. Zangani et al. conducted an experimental test and performed finite element analysis to predict the performance of aluminum welds in rail vehicles under highly dynamic loading condition and provided design guidelines to reduce the likelihood of the occurrence of weld unzipping [14]. Xue and Schmid presented a crashworthiness assessment of a conventionally designed railway passenger vehicle and suggest modifications for its improvement [15]. Witowski et al. presented the topology optimization of structures under highly non-linear dynamic loading, e.g. crash [16]. Chuang and Yang reviewed discussed three commercially available methods of topology optimization for crashworthiness design [17]. Jang et al. presented the numerical results on crashworthiness assessment and improvement scheme of tilting train mode of composite materials [18]. Anghileri et al. carried out simulations to verify the new tram AnsaldoBreda Sirio-Milano on the basis of EN 15227 standard [19]. Cerit et al. performed frontal crash analysis of the structure of a bus front body according to the ECE-R29 European regulation requirements and the strength of the bus structure was checked whether the safety requirements are satisfied [20]. Liana addressed grade-crossing collisions by

comparing a grade-crossing collision scenario from the CFR to a grade-crossing collision scenario from EN 15227 [21].

It can be seen that predominant research method in previous studies is finite element approach (FEA). On the other hand experimental tests are costly and maybe not affordable for railway industries to perform multiple tests. Also, due to the complexity of crush phenomenon, analytical approaches are not popular. Therefore, FEA is used in this research. The main aim of this paper is to study crashworthiness of an Eastern Germany carbody in accordance with EN 15227 standard. In the first step, the original structure of the carbody was modeled and analyzed. The results revealed the weakness of the structure against collision. Because of the traditional structure of the carbody, there is no mounted energy absorbing system. Due to the large scale usage of this type of wagon in Iranian railway network it is not practical to replace this structure with new trains as it needs a huge investment. Therefore, a key solution is to improve the existed structure in crashworthiness point of view. Hence, a new structure of chassis head stock is proposed in which honeycomb absorber layers is mounted at the end of the chassis. The Analyses illustrated that the suggested system can interestingly improve the crashworthy parameters of the carbody.

2. Finite Element Modeling

A conventional passenger rail vehicle, made in Eastern Germany, was modeled by using Abaqus engineering software package, Figure 1.

The carbody consists of chassis, side walls, end walls and the roof. All the major and minor structural components, braces, as well as, floor structures, wall structures and outer shell structure were modeled, Figure 2.

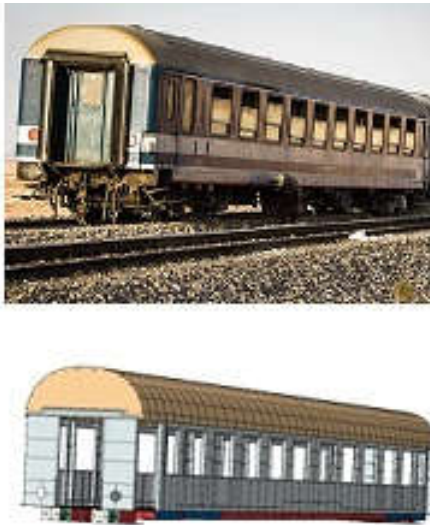

Figure 1: A conventional passenger rail vehicle, Top: The real train, Bottom: The finite element model

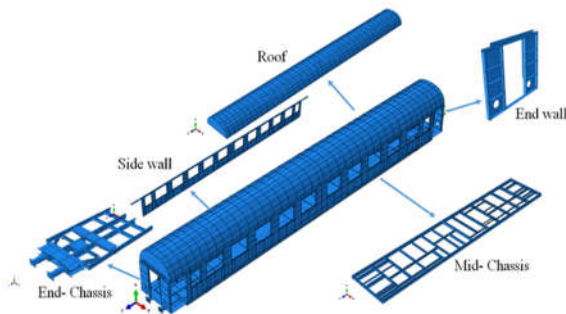

Figure 2: Components of the rail vehicle carbody

The rail vehicle was generated using 2D shell element and 3D solid element to ensure obtaining reliable numerical result. The carbody is made of ST37 and ST52 steel alloys, Table 1.

Table 1: Mechanical properties of steel and aluminum alloys

Material	Elasticity		Density (kg/m ³)	Yield stress (MPa)
	Young modulus (MPa)	Poisson's ratio		
Steel- ST37	210000	0.3	7850	235
Steel- ST52	210000	0.3	7850	350
Aluminum alloy 5052	70000	0.33	2700	193

Nonstructural masses are attached to the carbody by coupling reference points to the relative regions and assigning the defined masses, Figure 3.

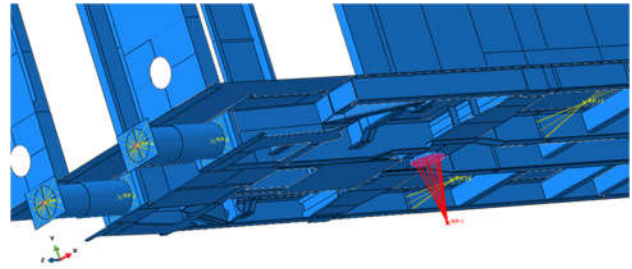

Figure 3: Coupling constraints to consider nonstructural masses of the wagon

The magnitude of the nonstructural masses are listed in Table 2.

Table 2: The magnitudes of the nonstructural masses attached to the carbody

Component	Mass (kg)
Ventilation system	800
Water tank	300
Bogie	4300

A rigid wall is created to simulate train-wall collision in correspondence with EN 15227 standard. Buffers are modeled by spring/dashpot elements on the basis of EN 15227 standard, Figure 4.

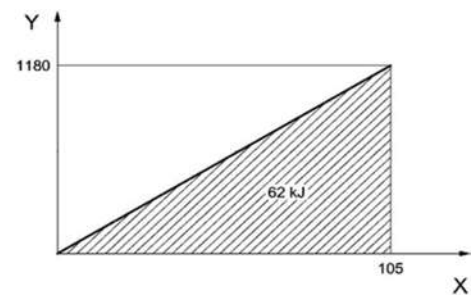

Key
 Y force – 2 buffers, in kN
 X displacement, in mm

Figure 4: Mechanical properties of buffers [22]

The carbody and the rigid wall were assembled with a little distance to have a better stability at the beginning of the analysis. The initial velocity was imposed to the carbody while the rigid wall was fixed in all of DOFs, Figure 5.

According to EN 15227 standard, crush cases with velocities of 36km/hr were considered. ABAQUS/Explicit solver was used to conduct simulations.

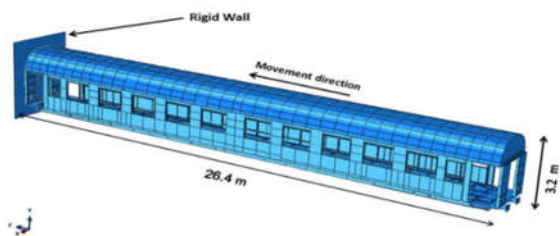

Figure 5: Finite element model of train-wall crash scenario

3. Results and Discussion

3.1 Analysis of the Original Carbody

The carbody structure was meshed using 2D shell element and 3D solid element, Figure 6. Table 3 illustrates mesh properties of the FE model.

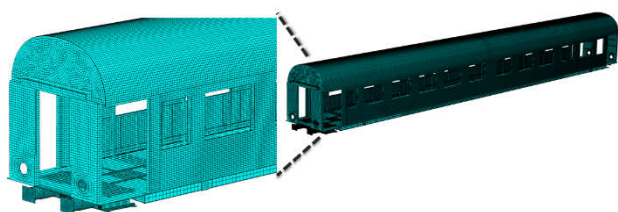

Figure 6: Meshed structure of the carbody

Table 3: Mesh properties of the carbody components

	Chassis	Side walls	End walls	Roof
Element type	C3D8,C3D6	S4R	S4R	S4R,S3R
Element number	63119	71274	6834	70097

According to EN 15227 standard four classes (C1-C4) are arranged with associated crash scenarios. Locomotives and passenger wagons are in C1 class, C2 class encompasses subway rail vehicles and finally C3 and C4 classes include tramways. Also, the average longitudinal acceleration magnitude in the course of each crash scenario must be less than 5g. Simulations were carried out on a cluster system with 22 computing units of 2.2 GHz and 8 GB RAM capacity.

Approximately 12 hours were needed per analysis to complete. The analysis time period was set enough to capture the crash and rebound of the structure. Initially the original carbody was analyzed to observe its crashworthiness and crucial parameters such as absorbed energy and then reaction force were obtained.

3.2. Analysis of the Modified Carbody

Passive safety performance is a crucial issue that keeps a survival space when a crash occurs, Figure 7.

It is a key to minimize the risk of injury to the crew and passengers. Because of the traditional structure of the original carbody, there is no energy absorbing device at the front of the ends of the structure.



Figure 7: Collision of the passenger train [23]

The authors tried to construct an energy absorbing device on the head stock of the chassis in order to improve energy absorption property of the original carbody. It was expected to acquire a crashworthy structure to absorb energy in a stable manner and the carbody shell itself withstanding large deformation. At the beginning, some modifications were carried out on the head stock structure in order to gain enough space to attach absorber components. Figure 8 second section shows the modified and the original structure of head stock. The new structure consists of two cylinder and a hollow rectangular box which are made by aluminum alloy with thickness of 4 mm.

Similar analyses were carried out and the associated results were obtained. Figure 9 illustrates

the crushing behavior of the original and first design structures. It can be seen that the frontal deformation of the structure in the original design is lower than the first improved design. This means

that in the original carbody the crush zone is not efficient and most of the impact energy is transferred to the passenger compartment.

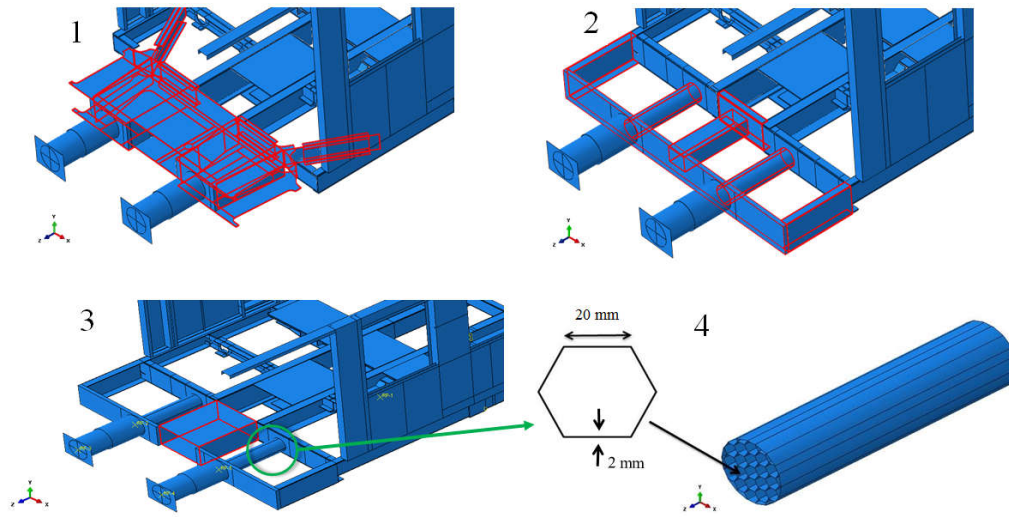

Figure 8: The stages of the energy absorbing system design

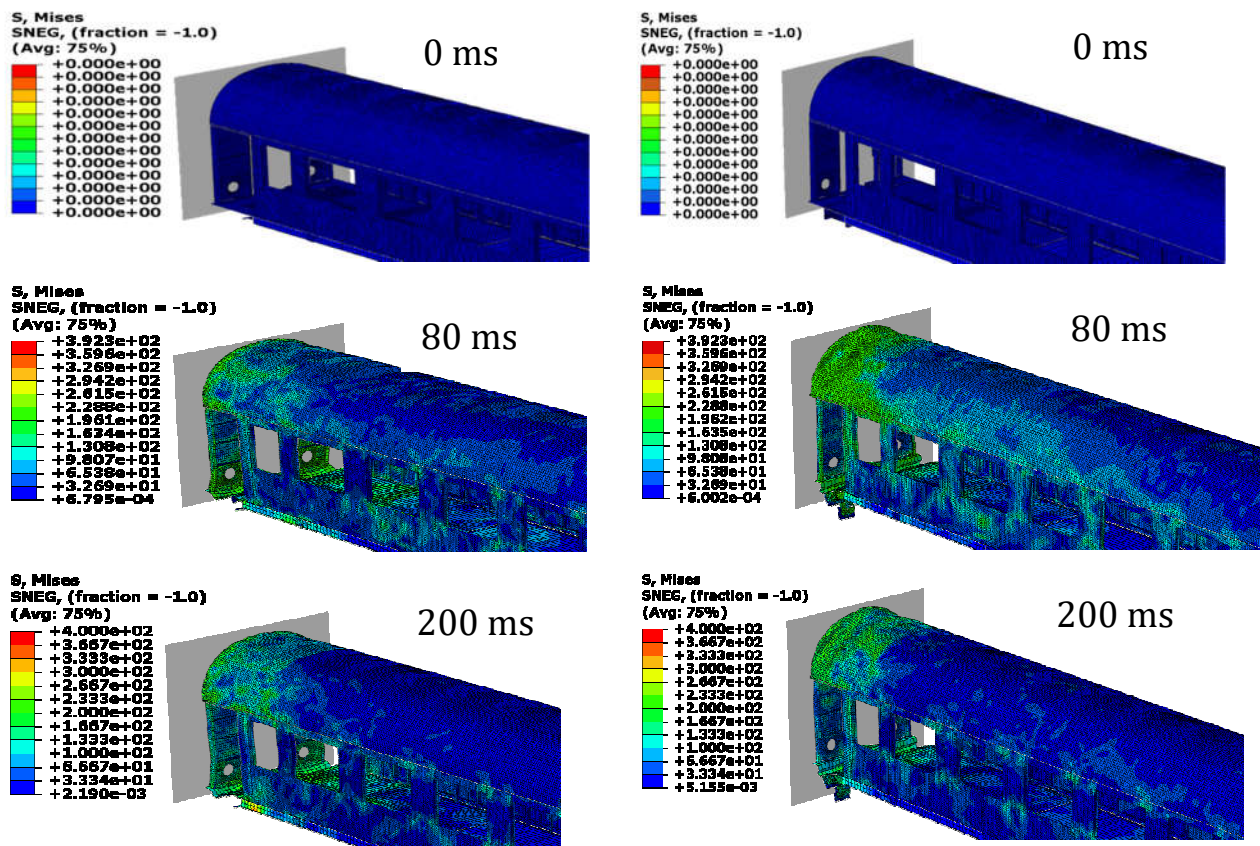

Figure 9: Deformation levels of the original carbody (left) and the second design (right) in a course of crash at the speed of 36 km/h

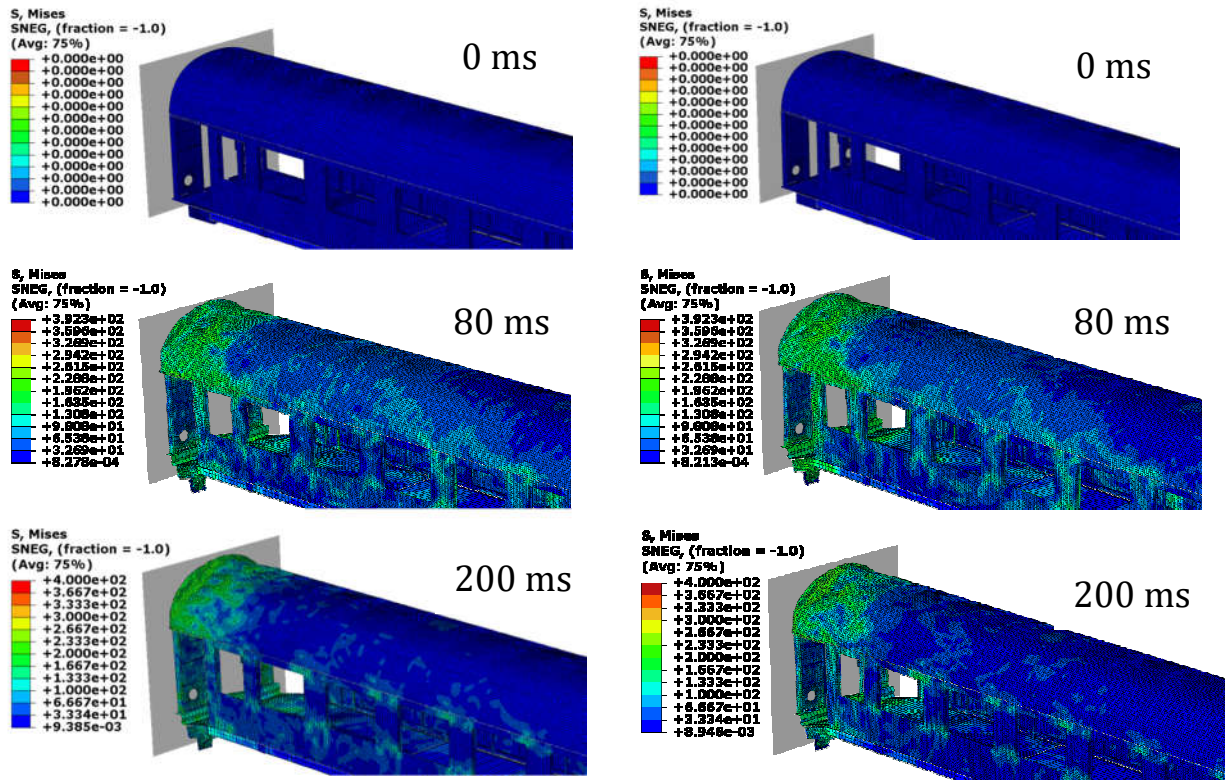

Figure 10: Deformation levels of the third design (left) and the fourth design (right) in a course of crash at the speed of 36km/h

Albeit achieving stable energy absorption, the proposed structure in the second design does not include the space needed for installing connectors such as the wagon hook. Therefore, the box was replaced with a new structure which was shown in Figure 8(3). This structure is named as the third design in this paper. In order to improve the performance of the energy absorption block, owing to its low weight and high energy absorption capacity [24-26], an aluminum honeycomb structure is inserted into the cylinders, the honeycomb dimensions can be found in Figure 8(4). Therefore, two more series of crush analyses were carried out and the results compared. Figure 10 presents the deformation in course of crush for the third and the fourth designs.

It is clear that the crush zone experiences large deformation. Furthermore, implementing honeycomb structures substantially improve the crashworthiness of the structure is explained. Force-displacement characteristics at the front-end structure are shown in Figure 11. In can be seen

that the maximum reaction force for the original structure captured initially and is approximately 12 MN and the second peak force is nearly 8 MN. In other cases, the maximum reaction force at the first peak and the second peak is about 8 MN. Therefore, the maximum force decreases about 50% in comparison with the original structure. Moreover, the maximum displacement in the original structure is about 300 mm which leads sever rebounding of the structure and large variation in acceleration magnitude. These variations endanger passengers and expose them to injury. In design 2 and 3 the maximum displacement increased up to 400 mm and is 25% more than the original structure. Also, in the 4th design, due to the existence of HC blocks, crushing behavior improved significantly and the structure can bear crush loads in steady manner and the crush zone deforms up to 450 mm which is 50% higher than that for the original structure.

The magnitudes of the absorbed energy of the structures are illustrated in Table 4. It can be seen

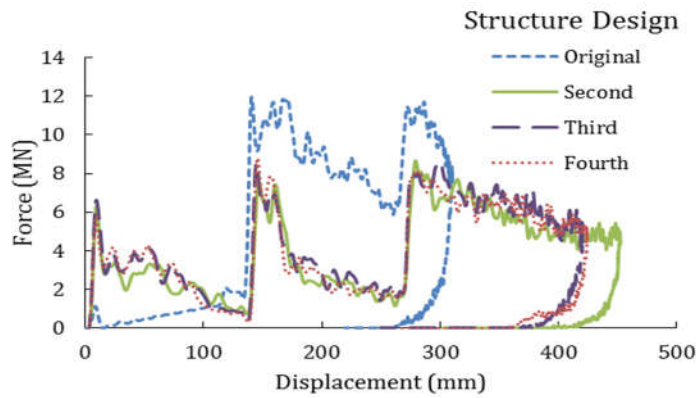

Figure 11: Force-displacement characteristic of the front-end structure of the carbody

Table 4: The absorbed energy of the structure

	Original design	2th design	3th design	4th design
Absorbed energy of whole structure (MJ)	2.8	3	3.3	4.1
Absorbed energy of roof (MJ)	0.23	0.75	0.68	0.69

that the absorbed energy of the whole structure for the original design is about 2.8 MJ while this value increases up to 4.1 MJ for the 4th design. Therefore, the proposed energy absorption structure interestingly enhanced this parameter up to 46%.

Furthermore, the absorbed energy of the roof is also compared. In the original model, due to the high rigidity of the end chassis, the roof undergoes insignificant deformations, Figures 12-13. Since the roof plays an important role in crashworthiness of the structure its participation in overall dissipated energy should also be considered.

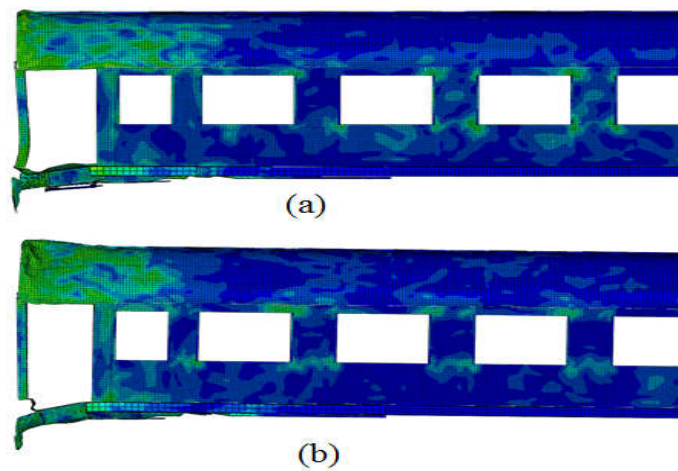

Figure 12: Deformation of the structure; (a) the original structure, (b) the fourth design

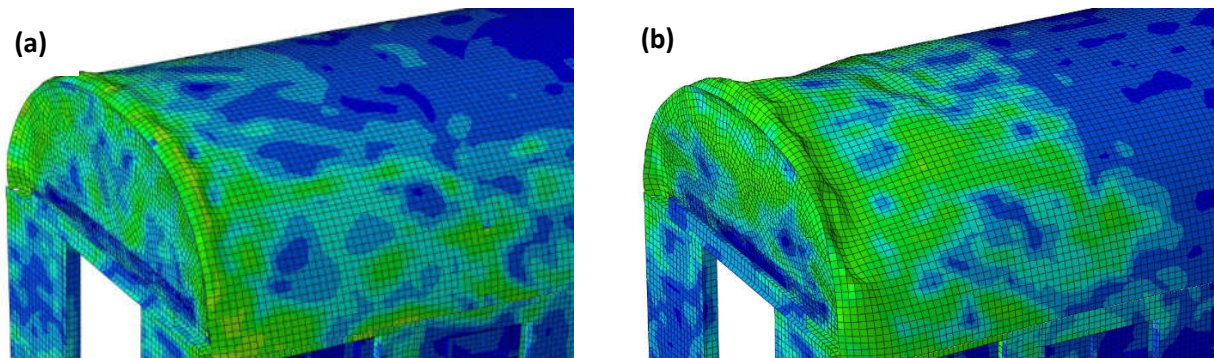

Figure 13: Deformation of the roof; (a) the original structure, (b) the fourth design

When a crush occurs the impact energy distributes through the structure and if the crash zone does not absorb a big portion of the imposed energy, the passenger compartment experiences high amount of stress. This occurrence should be descending as much as possible in order to have a crashworthy structure. To pinpoint the variation of stresses at the middle of the chassis, a finite region on the chassis is specified in which associated maximum stresses in each case were derived. Table 5 shows the maximum stresses at the middle of the chassis.

Table 5: Maximum stress at the middle of the chassis

	Original design	2th design	3th design	4th design
Maximum stress (MPa)	242	97	95	81

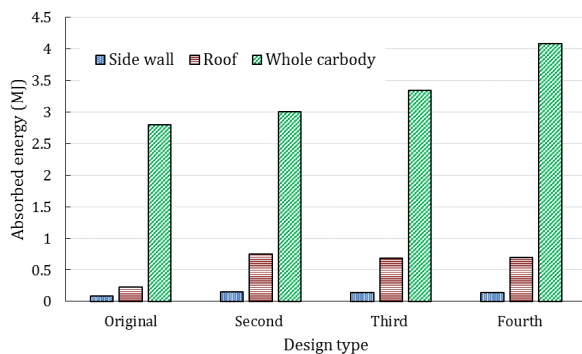

Figure 14: Energy absorption of the carbody components

It can be seen that in the original structure the maximum stress is around 242 MPa and is close to the yield point of the material. By modifying the head stock geometry this value drops to 97 MPa and by implementing HC structure, the maximum stress decreases to 81 MPa. This reveals 198% decrease in the stress magnitude at the middle chassis in comparison with the original structure. The absorbed energy of the car body components are shown in Figure 14. It can be seen that in the original design the absorbed energy is about 0.23 MJ. Modification of the chassis interestingly improved energy absorption of the roof as this value is nearly 0.69 MJ for the fourth design that means 200% higher than that for the original design. Furthermore, the absorbed energy by the side walls also reveals that the proposed crashworthy structure interestingly enhanced this value in comparison with the original design. In the fourth design the end walls absorbed 0.14 MJ while this value for the original model is only about 0.08 MJ.

4. Conclusions

In this study crashworthiness of a rail vehicle was conducted to propose energy absorbing system to improve the structures performance against crashes. European EN 15227 standard, which was proposed by CEN/TC 25 technical committee, was the basis of the performed analyses. In this research the scenario of train-wall crash was implemented. Initially, the original carbody was analyzed and it was observed that the structure is not crashworthy. Therefore, an absorbing system was developed that needed some modifications on the headstock. Worthwhile results were obtained which proved the

efficiency of the suggested energy absorption device. This structure can be implemented in the rail vehicle carbody to reduce injuries caused by collision or derailment and the results show that the amounts of the maximum stress for optimum design related to the original design were reduced by 66%, and also, the amounts of absorption of energy were increased by 46%. It is worth noting that this study was a fundamental survey of the crashworthiness of the proposed structure. Other analyses, to finalize the new structure, should be carried out to assure that all of the requirements are satisfied. The carbody strength, in correspondence with EN12663, should be determined and after conducting associated tests the optimum crashworthy carbody can be produced and implemented in the commercial railway network.

References

- [1] J H Lewis, W G Rasaiah and A Scholes, Validation of measures to improve rail vehicle crashworthiness, Proceedings of the Institution of Mechanical Engineers, Part F: Journal of Rail and Rapid Transit (1996) 210: 73.
- [2] L.M Cleon. Resistance passive application au TGV 2N, Revue Generale Des Chemins Der Fer, (1993) 65F, 45-63.
- [3] R. Mayville, A.D. Little, K. Johnson and D. Tyrell, The development of a rail passenger Coach Car crush zone, Proceedings of the 3th International Symposium, Passive Safety of Rail Vehicles, Berlin, 2002.
- [4] E.C Chirwa, Crashworthiness in rail vehicles, In Proceedings of Railtech '94 ImechE Conference, May (1994), C47/13/002.
- [5] R.A Smith, Crashworthiness of trains: principles and progress, IV symposium on Crashworthiness and occupant Protection in Transportation System, San Francisco, ASME Congress, November (1996).
- [6] S. Leutenegger, A. Stralinger and J. Zehnder, Light weight structures meet tougher crashworthiness standards, Railway Gazette International, (2001) 101-104.
- [7] JH Lewis, A Minnis and O Rogers, Investigation of a collision between an IC225 Train and a land rover at GREAT heck, AEA Technology Rail. Report No. AEATRT & S-2001-122, September 2001.
- [8] W Walter, Impact of safe train results on new European standard of crashworthiness of rail vehicles, Berlin, March 2002.
- [9] K Jacobsen, D Tyrell, and A.B Perlman, Impact test of a crash energy management passenger rail car. Rail Conference, 2004, Proceedings of the 2004 ASME/IEEE Joint, Baltimore, USA, 6-8 April (2004).
- [10] S Spirka, V Kemka, M Kepka and Z Malkovsk'y. Design of a large deformable obstacle for railway crash simulations according to the applicable standard, Applied and Computational Mechanics 6 (2012) 83–92.
- [11] M Carolan, D Tyrell and A.B Perlman, Performance efficiency of a crash energy management system, ASME/IEEE Joint Rail Conference & Internal Combustion Engine Spring Technical Conference. 13-16 March, 2007.
- [12] J Carruthers, C O'Neill, S Ingleton, M Robinson, M Grasso, J Roberts, J Prockat and G Simmonds, The design and prototyping of a lightweight crashworthy rail vehicle driver's cab. In: 9th World Congress on Railway Research, France 2011.
- [13] D Tyrell, K Jacobsen, E Martinez and A.B Perlman, A train-to-train impact test of crash energy management passenger rail equipment: structural results, ASME International Mechanical Engineering Congress and Exposition, Chicago, 5-10 November 2006.
- [14] D Zangani, M Robinson and G Kotsikos, Improving the crashworthiness of aluminum rail vehicles, Engineering against Fracture: Proceedings of the 1st Conference, Springer 2009.
- [15] X Xue and F Schmid, Crashworthiness of conventionally designed railway coaching stock and structural modifications for enhanced performance, 5th European LS-DYNA Users Conference, 2005.
- [16] K Witowski, A Erhart, P Schumacher and H Mullerschon, Topology optimization for crash, 12th European LS-DYNA Users Conference, 2009.
- [17] C.H Chuang, R.J Yang. Benchmark of topology optimization methods for crashworthiness design, 12th European LS-DYNA Users Conference, 2009.
- [18] H.J Jang, K.B Shin and S.H Han, Numerical study on crashworthiness assessment and improvement of composite carbody structures of tilting train using hybrid finite element model, Advanced Composite Materials, March 2013.
- [19] M Anghileri, L.M.L Castelletti, M Pirola, F Pistochini and S Raiti, A new impact scenario for P-V tram certification, 6th European LS-DYNA Users Conference, 2007.
- [20] M.E Cerit, M.A Guler, B Bayram and U Yolum, Improvement of the energy absorption capacity of an intercity coach for frontal crash accidents, 6th European LS-DYNA Users Conference, 2007.
- [21] P.G Liana, Structural crashworthiness standards comparison: Grade-crossing collision scenarios. Rail Transportation Division Fall Technical Conference. October 20-21, 2009, Ft. Worth, Texas, USA.

[22] Railway applications - Crashworthiness requirements for railway vehicle bodies. EN 15227, January 2008.

[23] Khabar Online website,
<http://www.khabaronline.ir/detail/256977/society/events>

[24] H Mozafari, S Khatami and H Molatefi, Out of plane crushing and local stiffness determination of proposed foam filled sandwich panel for Korean tilting train express–numerical study, *Materials & Design*. Vol. 66, Part B (2015), pp. 400–411.

[25] V Crupi, G Epasto, E Guglielmino, H Mozafari and S Najafian, Computed tomography-based reconstruction and finite element modeling of honeycomb sandwiches under low-velocity impacts, *Journal of Sandwich Structures and Materials*, Vol. 16, No.4(2014)pp. 377-397.

[26] H Mozafari, H Molatefi, V Crupi, G Epasto and E Guglielmino, In plane compressive response and crushing of foam filled aluminum honeycombs, *Journal of Composite Materials*, 27 November 2014.