



## Assessment and comparing the lubrication quality of solid lubricants made of graphite and MoS<sub>2</sub> used for wheel flange/rail gauge corner lubrication by using pin-on-disc tribometer

Kamran Moradian<sup>1\*</sup>, Mahmoud Farzin<sup>1</sup>, Mehdi Karevan<sup>1</sup>, Saleh Akbarzadeh<sup>1</sup>

<sup>1</sup>Department of Mechanical Engineering, Isfahan University of Technology, Isfahan, 84156-83111, Iran

### ARTICLE INFO

#### Article history:

Received: 07.15.2023

Accepted: 09.05.2023

Published: 09.09.2023

#### Keywords:

Solid lubricant

Wheel flange

Rail gauge corner

Pin-on-disc

Wear

### ABSTRACT

In light of the widespread application of solid lubricants for wheel flange lubrication and selecting the best composition of these products, three well-known lubricant blocks incorporating 30% graphite, 30% MoS<sub>2</sub>, and a mixture of 15% graphite and 15% MoS<sub>2</sub> have been assessed using a pin-on-disc apparatus at pure sliding conditions. All the specimens, which were encapsulated in an identical thermosetting resin, were evaluated at a sliding speed ( $V=0.6$  m/s) and two different normal loads ( $F=25, 50$  N), followed by representing the results in terms of coefficient of friction graphs, retentivity graphs, and wear rate charts. According to the results, the lubricant which comprised a mixture of graphite and MoS<sub>2</sub> was superior to the others, with the reduction of COF by 94%. Following that, the MoS<sub>2</sub>-based lubricant and graphite-based lubricant diminished COF by 91% and 88%, respectively.

## 1. Introduction

Lubrication is considered among the most effective methods of maintenance in order to diminish wear, energy consumption, and noise generation. Lubricants are applied between wheel and rail in curves with the aim of decreasing friction-resulting in a decline of the wear of wheel flange and rail gauge corner in high rail, corrugation growth in low rail, and noise generation at both high and low rails [1]. There are various methods of lubrication constituting a lubricant film in the contact area of the wheel flange and rail gauge corner. Solid lubricants are among the usual modes of lubrication, parallel to oil, grease, and other fluid lubricants. Being solid, these lubricants are unable to flow and spread over adjacent components and areas.

There are requirements for lubricants in DIN EN 16028 to maintain coefficient of friction (COF) and wear at accepted levels. What is more, procedures have been proposed to evaluate lubrication properties of them. For instance, a twin-disc methodology has been suggested to evaluate the lubrication of solid lubricants [2]. Being complex, the interaction of wheel and rail comprises various forces in various directions. For the simulation of the interaction, different rigs have been designed so far that the movement of a wheel on a rail can be practically simulated. Descartes et al. [3] conducted research for the enhancement of grasp of wheel/rail wear mechanisms and proposed an approach to assess new lubricants suitable for the wheel flange-rail gauge corner contact. In this research, a special apparatus has been used to simulate rolling-

\*Corresponding author

Email address: [info.ipico@gmail.com](mailto:info.ipico@gmail.com)

sliding contact. The apparatus incorporated a roller-a wheel simulator- and a rail able to move linearly. Abbasi et al. [4] studied the impact of railway friction modifiers on airborne wear particles from wheel-rail contacts using pin-on-disc methodology. The study was carried out in both dry and lubricated conditions. Lewis et al. [5] evaluated the lubrication properties of different lubricants and measured their retentivity using a twin-disc machine. Maya-Johnson et al. [6] studied the wear behavior of rail steels (R370CrHT) under rolling contact fatigue conditions. The research has been carried out by a twin-disc machine in dry and lubricated conditions.

Khalladi et al. [7] investigated the effect of contaminants such as sand, phosphate, sulfur, and cement on the tribological behavior of wheel-rail contact using the pin-on-disc methodology. The results of the test were represented for both wheel flange-rail gauge corner contact and wheel tread-rail head contact. Lyu et al. [8] utilized a pin-on-disc tribometer to investigate the tribology of cast iron, sinter, and composite railway brake blocks at different temperatures. In that research, pins and discs were made of different brake blocks and steel wheels, respectively. Almeida et al. [9] carried out research on understanding wear mechanisms under typical contact conditions using a pin-on-disc machine at various sliding speeds and a constant normal load.

Junaidi et al. [10] evaluated the impact of graphite on the wear level of the surface of a wheel using a twin-disc tribometer. The results of the research revealed that higher velocity results in a higher wear rate. However, graphite can diminish wear rates by 175%-600%. Tan et al. [11] assessed a Cu@Graphite solid lubricant by a ball-on-block rig at different sliding speeds. According to the results of the research, the solid lubricant reduced the COF between friction pairs by in excess of 400%, and wear volume also declined considerably.

L. Fusaro [12] proposed experimental methods to assess solid lubricant films using a pin-on-disc

tribometer. According to the research, one of the methods to apply lubricant onto the disc surface is to use a polishing cloth and rub solid lubricant powder onto the disc surface by hand. Furthermore, the most common strategy is to incorporate lubricant powders into a binder system. Nevertheless, in this method, cleaning and binding qualities are vital to forming a lubricant film on the surface. What is more, several stages are needed to form the film. Evaluating the effect of temperature, L. Fusaro claimed that higher temperatures reduce the endurance life of solid lubricant films. The downside of the method was that test time was dependent on the endurance life of the film, and it was also impossible to replenish the film while carrying out the test. Moreover, it was not suitable for high speeds in light of the brittle fracturing of the film.

The bulk of researchers who have evaluated solid lubricants so far have utilized twin-disc tribometers (at rolling-sliding conditions). Therefore, few studies have been carried out at pure sliding conditions using a pin-on-disc machine. Since in wheel flange-rail gauge corner contact severe friction is evident, especially in curves, applying pin-on-disc methodology is superior to twin-disc methodology to simulate pure sliding conditions. It should be noticed that when the first wheelset of the leading bogie contacts the rail gauge corner, the tangential force reaches its saturation value, resulting in a pure sliding contact [13].

In this research, a pin-on-disc tribometer has been used to evaluate the performance of solid lubricant blocks in pure sliding conditions. That said, the method of applying solid lubricant onto the disc surface is a challenge in this methodology. In the research in which L. Fusaro used a pin-on-disc tribometer, the way of applying lubricant onto the disc surface was far from the real method, in which a solid lubricant film is constantly applied to the wheel flange surface.

Selecting the best composition of solid lubricant blocks has always been a challenge for

consumers in the railway industry. Hence, in this research, three common solid lubricant blocks comprising graphite, MoS<sub>2</sub>, and a mixture of graphite and MoS<sub>2</sub> were used in order to make an analogy between their performances and opt for the best one in terms of lubrication properties. The three specimens, made of an identical resin binder and containing equal lubricant content, were applied onto the disc surface using a gantry mechanism. By doing so, COF, retentivity, and wear rate have been measured at a constant sliding speed and two normal loads.

## 2. Experimental details

### 2.1. Solid lubricant specimens

Three solid lubricant samples have been made according to the composition written in Table 1. Containing identical thermosetting binders, all the samples had the same hardness and lubricant powder content. Nevertheless, the samples comprised different types of solid lubricant powder.

Table 1. Composition and hardness of the solid lubricant blocks

Lubricant sample	MoS <sub>2</sub> content (%)	Graphite content (%)	Hardness (Shore-D)
SL <sub>A</sub>	0	30	80±3
SL <sub>B</sub>	30	0	81±3
SL <sub>C</sub>	15	15	80±2

### 2.2. Applicator mechanism

One of the challenges in the assessment of solid lubricant blocks by pin-on-disc tribometers is applying solid lubricant film onto the disc surface. In order to constantly apply solid lubricants onto the disc surface, a gantry mechanism shown in Figure 1 has been designed. In fact, the mechanism was the simulator of the applicator, which is installed on the bogie of real trains. From the information supplied in Figure 1, it is evident that a tube was tied to the mechanism to accommodate a solid lubricant specimen. It should be taken into

consideration that the sample shape should allow the lubricant to move freely in the tube and the contact disc surface. Moreover, the position of the tube and dimensions of the samples should ensure that the sample is exactly positioned on the wear track while the pin-on-disc rig is run. After putting the sample in the tube, a rod with a weight on top should be put into the tube on the solid lubricant sample. The weight makes the constant force applied to the solid lubricant block, which is made by a spring in real applicators.

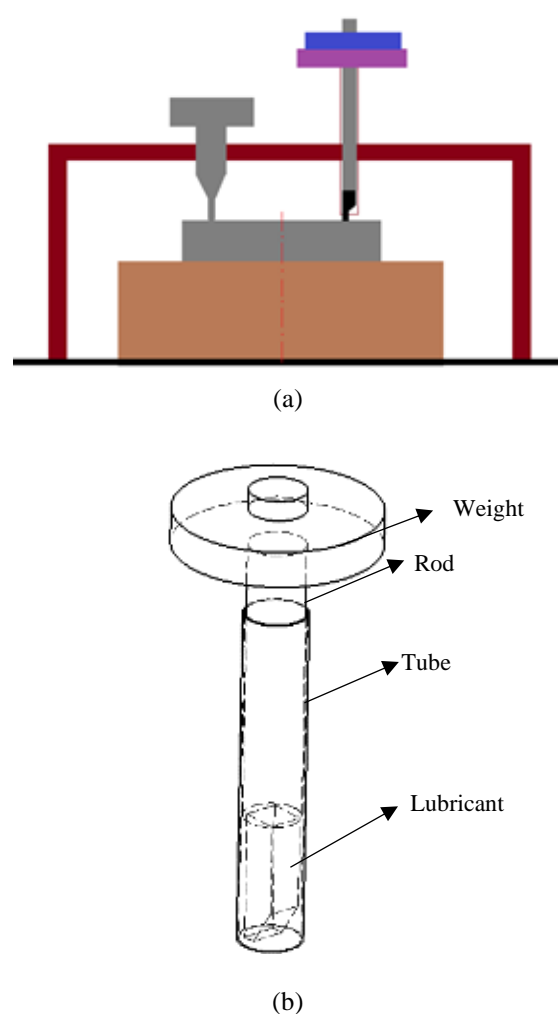

Figure 1. a) Gantry mechanism positioning and components, b) how to assemble components inside the tube of the applicator.

### 2.3. Test condition

The conditions in which friction tests were conducted and the parameters that were set for the tests are reported in Table 2. According to the

paper published by Sundh et al. [13], for the railhead-wheel tread contact, the sliding speed and contact pressure do not exceed 0.1 m/s and 1.5 GPa, respectively. Nonetheless, the maximum sliding speed and contact pressure were reported to be 0.9 m/s and 2.7 GPa, respectively, for the wheel flange-rail gauge corner contact.

Table 2. Test conditions and parameters

Test condition or parameter	Quantity or description	unit
Sliding speed	0.6	m/s
Track diameter	47.75	mm
Normal load (on Pin)	25,50	N
Hertzian maximum contact pressure	1.74, 1.38	GPa
Normal load (on solid lubricant)	10	N
Temperature	28±2	°C
Relative humidity	25±5	%
Pin material	52100 Steel (100Cr6)	*
Pin hardness	710	HV
Pin tip radius	10	mm
Surface roughness of the pins (Ra)	0.05	µm
Disc material	Steel CK45	*
Disc hardness	160	HV
Surface roughness of the discs (Ra)	0.3-0.6	µm
Sliding distance (dry)	300	m
Sliding distance (lubricated)	1000	m
Sliding distance (Semi-lubricated)	300	m

## 2.4. Test procedure

Initially, discs and pins were ultrasonically cleaned using ethanol for 15 minutes and then dried completely. Following that, the initial weight of the discs was measured and recorded. The test procedure is divided into three distinct stages, each of which will be described below. To ensure the repeatability of the results, the tests were repeated three times.

### 2.4.1. Dry contact

In this step, the friction test was carried out without applying lubricant for both of the normal loads mentioned before. Afterward, a graph of

COF was drawn, and the wear rate was calculated based on the weight of the worn discs.

### 2.4.2. Lubricated contact

In the next step, the solid lubricant samples were constantly applied onto the disc surface, and a friction test was carried out over a 1000-meter sliding distance. The corresponding COF graphs were also drawn, and the wear rate was calculated.

### 2.4.3. Semi-lubricated contact (retentivity)

Prior to beginning the third step, a solid lubricant sample was extracted from the applicator, and the debris produced in the second stage due to wear was collected. It should be noticed that the worn particles of the lubricants have remained on the surface asperities of the wear track on the discs. The test was conducted over 300 m, and a COF graph was drawn for each solid lubricant.

## 3. Results

The COF graphs obtained from each lubricant in each stage are represented in Figure 2. It should be taken into consideration that in this method, the results of each lubricant should be compared with others, and the results of each stage should be compared with other stages. This way, it can be possible to reach a decision about the superiority of the solid lubricant composition.

### 3.1. Dry contact

According to Figure 2 (a), at F=25 N, the COF fluctuated between 0.15 and 0.2 for approximately 40 meters, which was due to the presence of an oxidized layer on the surface of the discs. After removing the layer, the COF soared to 0.75 and then met fluctuations between 0.7 and 0.8 for almost 150 meters. From this distance onward, it saw a decline to 0.6.

Furthermore, at F=50 N, the COF initially went through fluctuations from 0.15 to 0.2 for roughly 20 meters, followed by an abrupt rise to 0.85 after the removal of the oxidized layer. Next, for about 100 meters, it fluctuated in the range of 0.75-0.85 and then proceeded to fluctuate from

0.7 to 0.75 by the end of the sliding distance, at 1000 meters.

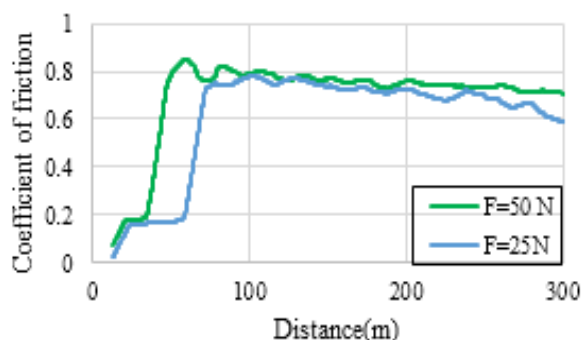

(a)

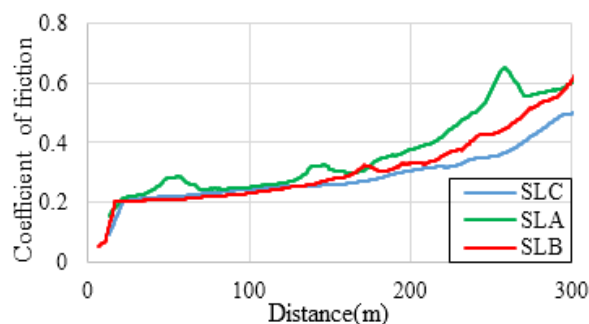

(e)

Figure 2. COF graphs for a) dry contact, b) lubricated contact at  $F=50$  N, c) lubricated contact at  $F=25$  N, d) semi-lubricated contact at  $F=50$  N, e) semi-lubricated contact at  $F=25$  N.

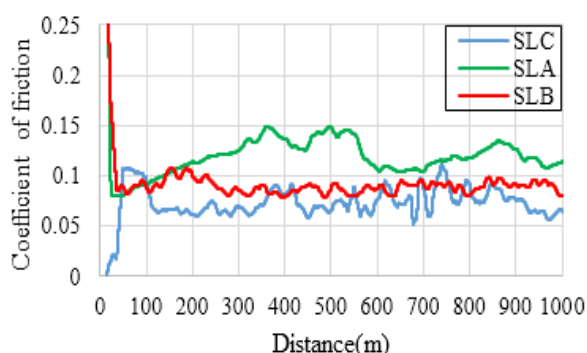

(b)

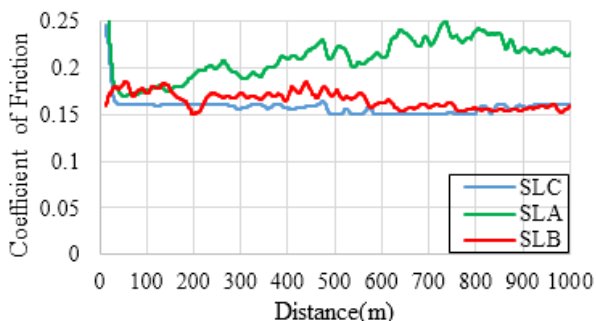

(c)

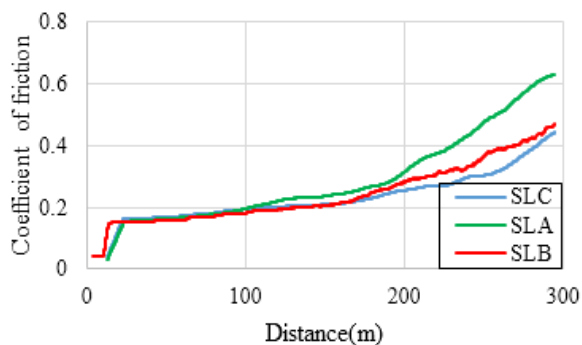

(d)

### 3.2. Lubricated contact

From the information supplied in Figure 2 (b), it is evident that at  $F=50$  N, the COF of  $SL_A$  ranged from 0.1 to 0.15 and demonstrated numerous fluctuations on top of other lubricants. Nevertheless, the COF of  $SL_B$  showed fluctuations ranging from 0.07 to 0.1 in spite of an increase to 0.12 at some points. It is also striking that the COF of  $SL_C$  was less than other samples in the range of 0.05-0.1, although it underwent the most fluctuations in comparison to the other specimens.

As for Figure 2 (c), at  $F=25$  N, the COF of  $SL_A$  initially experienced fluctuations between 0.17-0.21 for approximately 350 meters, and then the range of fluctuations shifted to 0.2-0.25. The COF of  $SL_B$ , on the other hand, fluctuated in the range of 0.15-0.18 for almost 800 meters between the other lubricants. One particularly interesting fact highlighted by the figure is that from 800-1000 meters,  $SL_B$  and  $SL_C$  represented approximately the same COF.

### 3.3. Semi-lubricated contact

It is apparent from the information provided by Figure 2 (d) that at  $F=50$  N, first of all, for about 100 meters, all the lubricants met fluctuations ranging from 0.15 to 0.2. After 150 meters of sliding, the COF of  $SL_A$  deviated from the others and started to rise. Moreover, the COF of the other lubricants was around 0.21 by the end of the 170-meter slide, and from this distance onward, an increase in the COF started. In other

words, even though the COF of SL<sub>B</sub> fluctuated above SL<sub>C</sub>, its fluctuations were under SL<sub>A</sub>.

With regard to Figure 2 (e), at F=25 N, it has been observed that SL<sub>B</sub> and SL<sub>C</sub> represented the same COF ranging from 0.2 to 0.25 by a 140-meter sliding distance, and then their COF started to increase and deviate from each other. In the range mentioned, although the COF of SL<sub>A</sub> was almost the same as the other lubricants in some periods, it has risen to 0.3 sometimes.

### 3.4. Wear rate

The wear rates calculated based on the weight of the discs are demonstrated in Figure 3. It is evident that the highest wear rate was calculated at dry contact and F=50 N. However, at lubricated contact, the highest wear rate was associated with SL<sub>A</sub>, while the lowest wear rates were obtained from SL<sub>B</sub> and SL<sub>C</sub>. What is more, at both normal loads, the wear rates of SL<sub>B</sub> and SL<sub>C</sub> have been approximately the same. It is also interesting to note that wear rates at F=50 N have been fewer than those at F=25 N.

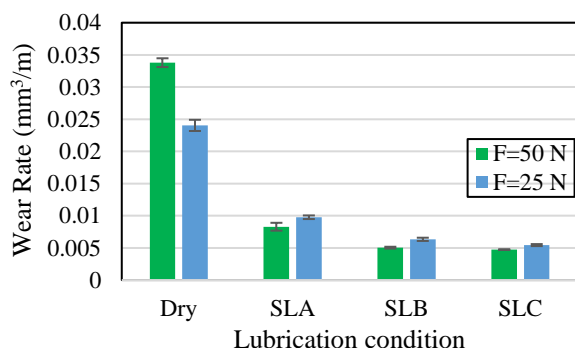

Figure 3. The bar chart of wear rates relevant to each solid lubricant at different normal loads

## 4. Discussion

Given the results of the current research, the lubrication of the three specimens at F=50 N was superior to F=25 N. This superiority was due to an increase in normal loads, resulting in severe friction, a rise in temperature, and surface roughness. These factors have an enormous impact on constituting and transferring a lubricant film from the solid lubricant block to

the disc surface, causing a thicker lubricant film on the disc surface.

It can be seen as the overall trend that all the samples diminished COF considerably in a way that SL<sub>C</sub>, SL<sub>B</sub>, and SL<sub>A</sub> reduced COF by 94%, 91%, and 88%, respectively. It is also striking that the maximum percentage of reduction mentioned has occurred at F=50 N. Plus, it has been observed that the performance of the lubricant that only contained MoS<sub>2</sub> was better than the one that only comprised graphite.

It should be taken into consideration that the performance of lubricants for wheel flange-rail gauge corner contact is reliant on numerous factors incorporating surface roughness, temperature, moisture, chemical and mechanical properties of polymeric binders, type of solid lubricant, contact condition, and so on, which are genuinely difficult to decouple from each other. The factors are able to impact each other while undergoing alterations themselves. Hence, every reason to justify the results obtained from the experiment is not entirely definite.

Graphite and MoS<sub>2</sub> are excellent lubricants in general and are widely utilized in various applications. MoS<sub>2</sub> is intrinsically a lubricant, as opposed to graphite, which needs adsorbed material or additives to develop lubricating capability. In fact, MoS<sub>2</sub> showcases its lubrication properties in the absence of such materials, and the ideal use of it is in vacuum applications. Oxygen and especially water vapor in room air pose a slow oxidative degradation of MoS<sub>2</sub>, leading to its loss of lubrication properties. Therefore, by eliminating or reducing oxidative factors, especially water vapor, MoS<sub>2</sub> will possibly be able to show lubrication far superior to graphite. For instance, solid lubricants bonded in resin show good shelf life and superior wear life in the air, owing to the oxidation protection afforded by the resin binder [14]. On the other hand, because it needs moisture in its structure to have lubrication properties, graphite has better performance in the presence of water vapor. On the contrary, MoS<sub>2</sub> is more effective in dry conditions [15].

Given the facts about the two solid lubricants, although this research has been carried out in the presence of moisture and warmth, the impact of them on the lubrication properties of MoS<sub>2</sub> declined considerably due to the resin binder in the samples, which resulted in a lower COF compared with graphite. Alternatively, it has been observed that the mixture of MoS<sub>2</sub> and graphite showed better performance than other samples. This superiority was in light of the fact that the simultaneous presence of these two lubricants in the sample suppressed drawbacks and boosted the lubrication properties of each other. Hence, the lubrication properties of the mixture were higher than those of each solid lubricant (graphite or MoS<sub>2</sub> alone). To clarify, even if moisture and heat had caused a reduction in the lubrication quality of MoS<sub>2</sub> (however minimal due to the protection caused by the binder), they would have enhanced the performance of graphite. Not only have heat and water vapor not undermined the lubrication of the sample but also boosted it.

From the retentivity results of the samples, it is evident that the endurance life of the lubricant film of MoS<sub>2</sub> was better than graphite. To explain the reason, it should be considered that, in addition to the reasons mentioned before for the better performance of MoS<sub>2</sub>, unlike graphite, MoS<sub>2</sub> is a dense and compact substance and disperses in the binder better than graphite. These features enhance the wear resistance of the lubricant and cause a more stable lubricant film between the friction pairs. Therefore, the endurance life of the MoS<sub>2</sub> film made in the contact area is higher than that of graphite [16]. When it comes to the mixture of the two lubricants, it has been observed that the endurance life of the lubricant film was the same as or slightly higher than that of MoS<sub>2</sub>. This was also owing to the synergy caused by the mixture of the lubricants, even though the impact of the synergy was more apparent at the COF of the lubricated contacts and wear rates.

For future studies, it is recommended to assess the effect of heat and moisture on solid lubricant

blocks used for wheel flange-rail gauge corner contact in depth. In other words, it would be informative to carry out friction tests and scrutinize the behavior of the lubricants at various temperatures. This is prominent in light of the presence of water vapor in the air and the generation of frictional heat, which is inevitable in wheel flange-rail gauge corner contact.

## 5. Conclusion

In this research, the lubrication properties of three solid lubricant blocks comprising graphite, MoS<sub>2</sub>, and a mixture of graphite and MoS<sub>2</sub>, used for wheel flange-rail gauge corner contact, have been assessed using a pin-on-disc rig and a gantry mechanism for the constant application of solid lubricant onto the disc surface. The friction tests were conducted at a constant sliding speed with a couple of normal loads, and the results were represented in the form of coefficient of friction graphs, retentivity, and wear rate charts. After analyzing and interpreting the data, the following conclusions have been drawn:

1. All the compositions played a decisive role in the reduction of COF and wear rate. The best solid lubricant in terms of maximum reduction of COF was the one comprising a mixture of graphite and MoS<sub>2</sub> with 94% reduction, followed in second place by the lubricant block comprised of MoS<sub>2</sub> with 91% reduction, and the last one was the lubricant made of graphite with approximately 88% reduction.
2. The lubrication properties of all the solid lubricants at the higher normal load ( $F=50$  N) were superior to those at the lower one ( $F=25$  N).
3. Despite the fact that the endurance life of the mixed lubricant was slightly better than or approximately the same as MoS<sub>2</sub>, the lubricant block containing graphite had the lowest endurance life.
4. Although the discrepancy between the results of the lubricant made of MoS<sub>2</sub> and the results of the mixed lubricant was slight (especially in retentivity), the difference between the results of the lubricant comprised of MoS<sub>2</sub> and the results of the lubricant made of graphite was considerable in all data (COF, retentivity, and wear rate).

## Declaration of Conflicting Interests

The authors declared no potential conflicts of interest with respect to the research, authorship, and/or publication of this article.

## References

- [1] Chen, H., S. Fukagai, Y. Sone, T. Ban, and A. Namura. "Assessment of lubricant applied to wheel/rail interface in curves." *Wear* 314, no. 1-2 (2014): 228-235.
- [2] Railway applications-Wheel/rail friction management-Lubricants for trainborne and trackside applications. 2012, DIN Deutsches Institut für Normung.
- [3] Descartes, Sylvie, Aurélien Saulot, Claude Godeau, Sandrine Bondeux, Camille Dayot, and Y. Berthier. "Wheel flange/rail gauge corner contact lubrication: tribological investigations." *Wear* 271, no. 1-2 (2011): 54-61.
- [4] Abbasi, Saeed, Ulf Olofsson, Yi Zhu, and Ulf Sellgren. "Pin-on-disc study of the effects of railway friction modifiers on airborne wear particles from wheel-rail contacts." *Tribology International* 60 (2013): 136-139.
- [5] Lewis, S. R., R. Lewis, G. Evans, and L. E. Buckley-Johnstone. "Assessment of railway curve lubricant performance using a twin-disc tester." *Wear* 314, no. 1-2 (2014): 205-212.
- [6] Maya-Johnson, Santiago, Juan Felipe Santa, and Alejandro Toro. "Dry and lubricated wear of rail steel under rolling contact fatigue-Wear mechanisms and crack growth." *Wear* 380 (2017): 240-250.
- [7] Khalladi, A., and K. Elleuch. "Tribological behavior of wheel-rail contact under different contaminants using pin-on-disc methodology." *Journal of Tribology* 139, no. 1 (2017): 011102.
- [8] Lyu, Yezhe, Ellen Bergseth, Jens Wahlström, and Ulf Olofsson. "A pin-on-disc study on the tribology of cast iron, sinter and composite railway brake blocks at low temperatures." *Wear* 424 (2019): 48-52.
- [9] de Almeida, Leandro Prates Ferreira, Leandro Entringer Falqueto, Hélio Goldenstein, Antônio Cesar Bozzi, and Cherlio Scandian. "Study of sliding wear of the wheel flange-rail gauge corner contact conditions: comparative between cast and forged steel wheel materials." *Wear* 432 (2019): 102894.
- [10] Junaidi, Joko Suparno, Dimas Halim Ardiansyah, Marwan Effendy, and Jamari. "Improvement of wear resistant of railway wheel by using graphite in various speeds based on disc-on-disc contact system." In *AIP Conference Proceedings*, vol. 2114, no. 1, p. 040005. AIP Publishing LLC, 2019.
- [11] Tan, Hai, Yanbao Guo, Deguo Wang, and Yongjie Cui. "The development of a Cu@Graphite solid lubricant with excellent anti-friction and wear resistant performances in dry condition." *Wear* 488 (2022): 204181.
- [12] Fusaro, Robert L. "How to evaluate solid lubricant films using a pin-on-disk tribometer." In *1986 Annual Meeting of the American Society of Lubrication Engineers*, no. NASA-TM-87236. 1986.
- [13] Sundh, Jon, Ulf Olofsson, and Krister Sundvall. "Seizure and wear rate testing of wheel-rail contacts under lubricated conditions using pin-on-disc methodology." *Wear* 265, no. 9-10 (2008): 1425-1430.
- [14] Sliney, Harold E. "Solid lubricants." (1991).
- [15] Vazirisereshk, Mohammad R., Ashlie Martini, David A. Strubbe, and Mehmet Z. Baykara. "Solid lubrication with MoS<sub>2</sub>: a review." *Lubricants* 7, no. 7 (2019): 57.
- [16] Chen, Baiming, Junxi Zhang, Jinlong Jia, Wei Hu, and Chenggong Gong. "Tribological properties of solid lubricants (graphite, MoS<sub>2</sub>) for Ni based materials." In *IOP Conference*.