



Optimization of Fan Geometry for Urban Train Traction Motors using Coupled Numerical Electromagnetic and Thermal Analysis

Amin Zargaran¹, Mehdi Soltanpour², Ali Rajabpour^{3*}

¹Research and Development Department of TAAM LOCOMOTIVE ARYA Co, Qazvin Science and Technology Park

^{2,3}Department of Mechanical Eng., Imam Khomeini International University, Qazvin, Iran

ARTICLE INFO

Article history:

Received: 5.07.2016

Accepted: 8.09.2016

Published: 14.12.2016

Keywords:

Heat generation

Train traction motor

Computational fluid dynamics

ABSTRACT

One of the most important parameters in designing electrical motors is heat generation by the motor and the way it is dissipated. Temperature rising reduce efficiency and reliability of traction motors and leads to failure. In this paper, an urban train traction motor in a 3D computational fluid dynamics (CFD) simulation has been investigated. Maxwell software for electromagnetic simulation and ANSYS Fluent for thermal simulation have been used. In the discussed motor, air is blown directly from atmosphere into the motor by embedded inlets and discharged to the atmosphere after passing through the motor components and fan. Heat generation rate has been derived from electromagnetic simulation results. At first step, the validity of the simulation results is evaluated by comparing the temperature distribution of motor using reference fan with the thermal requirements of the working class. Afterward, for two different blade geometries and different number of blades are. In the following, the optimized fan geometry is obtained by comparing the fan performance in each case.

1. Introduction

Electrical propulsion systems have been attracted much attention in development of clean transportation systems in recent years. In this way, Metro and urban trains as some of prevalent public transport systems in developing countries are extensively used. In this condition, induction motors as the most essential component of urban train's propulsion systems, in terms of performance, life and the maintenance cost are very important.

In induction motors, the operating temperature has direct effects on the efficiency, lifetime and breakdown of motors. For instance, coil electrical resistance increases when the operating temperature of the motor

raises which results to reduce the efficiency. Thus, coils are thermally well insulated in order to preserve their low temperatures and electrical resistances. Since the insulators used in coils have some restrictions and optimized performance at a certain temperature range, the electrical motors divided to various working classes based on their operating temperature. Thus, accurate and exact prediction of temperature distribution in these motors is greatly important. In addition, operating temperature of motor components such as rotor, stator and coil significantly influence on the lifetime of the motor. Hence, designing suitable cooling system for controlling the operating temperature of induction motors is crucial for proper performances.

*Corresponding author

Email address: Rajabpour@eng.ikiu.ac.ir

<http://tlx.doi.org/.....>

Heat generations in induction motors are mainly produced from two main sources of electromagnetic and mechanical losses. Electromagnetic losses include Iron, copper and stray losses and mechanical losses include bearings friction losses and windage losses, respectively. In recent years due to developments of finite element method and computational fluid dynamics, application of these methods to analyze the performance of electrical machines has increased. Boglietti et al. [1] investigated the thermal behavior of TEFC¹ induction motors using commercial software, Motor CAD, and verified the models experimentally. The results showed an accuracy of $\pm 5^{\circ}$ C on the winding² temperature, which would be acceptable for most applications. Wallerand and Laurent [2] Studied the thermal behavior of a permanent magnet motor at steady state and during a short-circuit using thermal networks. They also analyzed the performance of the motor using FEM³ simulations in Flux 2D, a commercial FEM software. The results showed that under thermal steady state with maximum torque, the temperature of the rotor is not high enough to present demagnetization problems. Kuria and Hwang [3] have conducted a CFD analysis on a Brushless DC motor to study the thermal behavior of the motor. They also studied effect of housing geometry on the heat dissipation and showed that using fins on the housing enhances heat transfer rate and the end winding temperature can be reduced by up to 15%. The computational results also show that additional cooling within the winding region may be necessary in order to protect the insulation and to reduce the winding temperature which has a direct impact on the copper losses. Chih-Chung et al. [4] carried out experimental and numerical investigations on motor cooling performance. Their aim was to determine pressure rise-flow rate (P-Q) performance curves of axial flow and centrifugal fans operating and to calculate the temperature distribution of the stator and rotor. They also presented a discussion on how to improve motor cooling performance. Li et al. [5] investigated a special type of electrical vehicle and found while the alloy thermal

conductivity coefficient increases, the temperature gradient in the vehicle becomes smaller. They also asserted when the ambient temperature increases, a smooth temperature distribution at different positions in the motor is obtained.

In most studies, the heat generated due to bearings losses has been neglected. However, Hwang and Kuria [6] showed that bearing losses account for close to 10% of the total motor losses. If the bearings located in the vicinity of the air of inside motor or have a contact with motor main component their loss must be taken into simulation. Kim and Seo [7] present the response surface optimization method using 3D Navier-Stokes analysis to optimize the shape of forward-curved blades centrifugal fan of an electrical motor. They showed with the optimization using four design variables the main objective, the efficiency was improved effectively in comparison with the reference fan. Especially, by employing flow rate as one of design variable, the optimization has successfully improved the efficiency by 3.1% in comparison with the optimization with fixed flow rate. They also had shown that the numerical optimization process with variable flow rate provides effective and reliable design of the fan with reasonable computing time. LI Xian-Zhang [8] used the computational fluid dynamics software FLUENT to establish three-dimensional model of a centrifugal fan. He has shown the gas velocity increases with the increase of the impeller radius and in that fan there are back flow phenomena near the exit of the spiral volute of centrifugal fan, which will reduce fan efficiency and increase fan noise. He was verified the numeral model by comparing simulation data to experimental data. Tao Sun and et al. [9] numerically simulated the inner flow field in a centrifugal fan of a motor and its flow characteristics. They showed the fan's ability had an obvious improvement after blade improved and internal efficiency is much better than original type especially at the large flow of time. Yu-Tai Lee and et al. [10] were worked on impeller design of a centrifugal fan with blade optimization. Based on their research, the flow turning area from the axial to the radial direction in front of the blade leading edge is required to be adequately designed to avoid the shroud flow separation. A blade leading-edge

¹ Totally Enclosed Fan Cooled

² Coil

³ Finite Element Method

extension and sweep into the shroud turning area prevents the air from separating from the shroud surface and improves the impeller's efficiency. They done a 2D blade profile optimization, based on a numerical coupling between a CFD calculation and a genetic algorithm optimization scheme. This optimization improves the impeller efficiency from 92.6% to 93.7%. They also showed the width of the impeller is almost linearly related to the impeller total head generated. However, the impeller efficiency remains nearly constant while the width changes.

This paper is a part of a national technology transfer project of urban train propulsion system design. In this study, an urban train traction motor, in terms of temperature distribution and the influence of the cooling fan geometry has been investigated. Heat generation rate has been derived from electromagnetic simulation results. Specifications of under study motor are presented in Table 1.

2. Simulation Details

2.1. Computational domain

In the simulation, components that have any influence on the fluid flow path and heat transfer are considered. Model details include: air inlet and outlet housings, shaft, rotor, stator, coils, rotor rods, fan and external casing. These

components are shown in the Figure 1. The inlet housing creates a pressure drop that prevents the backflow. Coils with their complex geometry are very influential in the motor operating temperature and should be considered in the simulation. However, some simplifications are made in coil geometry modeling. Blowing of air and fluid flow are provided by a centrifugal fan.

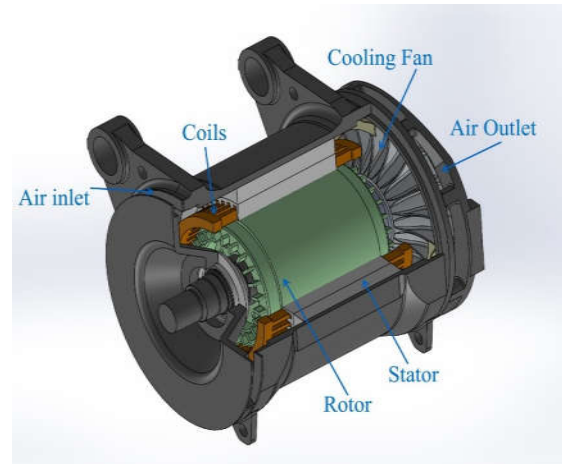

Figure 1. Computational Domain

In order to reduce the computational cost, the motor has been simulated by using periodical method. Accordingly one-sixth of the whole motor has been modeled which consists of more than 1,500,000 hexahedral and tetrahedral grid cells.

Table 1. Motor Specifications

Number	Specifications	Values
1	Motor Type	Squirrel Cage Induction
2	Rotor Outer Diameter	292 mm
3	Stator Outer Diameter	461 mm
4	Max. Speed	3740 m/s
5	Nominal Speed	1500 m/s
6	Nominal Torque	993 N. m
7	Power	180 kW
8	Stator Copper Loss	4.5 kW
9	Rotor Copper Loss	2.8 kW
10	Stator Iron Loss	0.735 kW
11	Rotor Iron Loss	0.357 kW
12	Stray Loss	1.5 kW

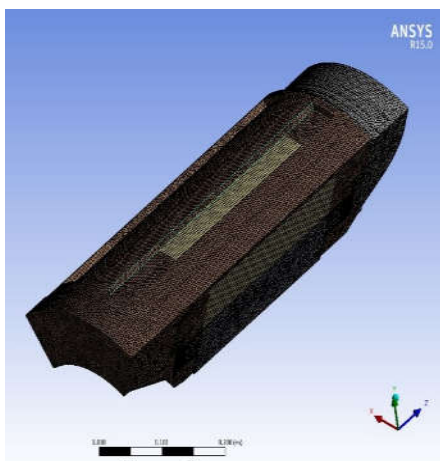

Figure 2. Generated Grid

2.2. Fan selection

In traditional approaches, fans are divided into two major categories: centrifugal and axial (flow) fans. Centrifugal fans normally produce more static pressure than axial-flow fans of the same wheel diameter and the same running speed. Axial flow fans, on the other hand, have the advantages of greater compactness and of easier installation.

According to their blade shapes, centrifugal fans can be subdivided into the following six categories: airfoil, backward curved, backward inclined, radial tip, forward curved, radial blade. Figure 3 shows this six commonly used blade shapes and also shows the approximate maximum efficiencies that usually can be attained with this blade shapes. Each of them has its advantage and disadvantage. However, many fans are built for low cost and have maximum efficiencies [11].

In addition to the geometry of the blades, quantities of them also will have a direct impact on performance of fan. It can be argued that for each fan there is one (or more) ideal value for quantity of blades. If the quantity is lower than mentioned amount full power of fan cannot be used and fan efficiency is reduced. If the quantity blades are too high, due to declining path available for the air, mass flow rate is reduced, which will be eventually lead to reduction efficiency. Hence, In addition to geometry of fan blades, finding a suitable value for quantity of blades is very important.

It should be noted that in the field of designing and manufacturing of fans, along with high efficiency, low cost has great important. Hence in electrical motors, generally, inexpensive construction method of fan such as casting is very significant.

In this paper, we are comparing the performance of the discussed motor with two different types of fan: radial blade and backward curved. Also we investigated each of them with two different blades quantity as 12 and 18 blades. It is worth mentioning that reference fan of discussed motor is a radial blade fan with 18 blades. In Figure 4-7 the geometry of each fan blades and arrangement of each type is shown.

2.3. Boundary conditions

At inlet, air is blown from ambient with temperature of 45°C. So a boundary condition with atmospheric pressure was applied to inlet of the computational domain. At the end of the motor, there is a centrifugal fan that creates a

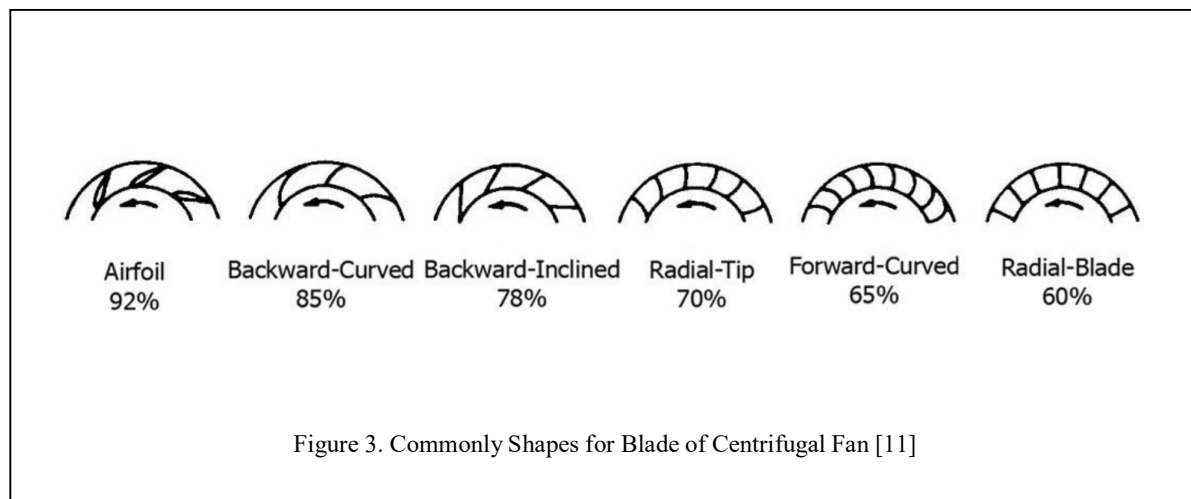

Figure 3. Commonly Shapes for Blade of Centrifugal Fan [11]



Figure 4. Radial Blade with 18 Blades

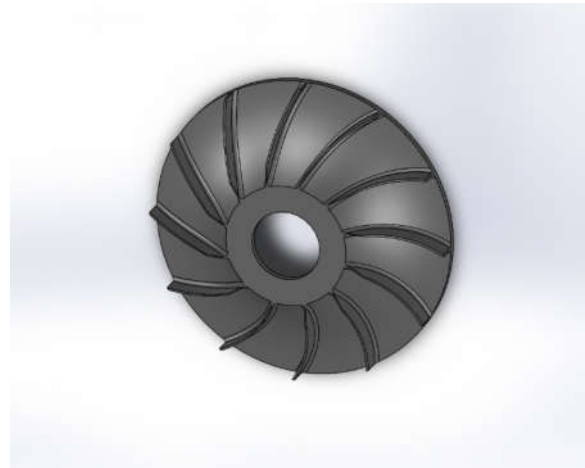

Figure 7. Backward Curved with 12 Blades



Figure 5. Radial Blade with 12 Blades

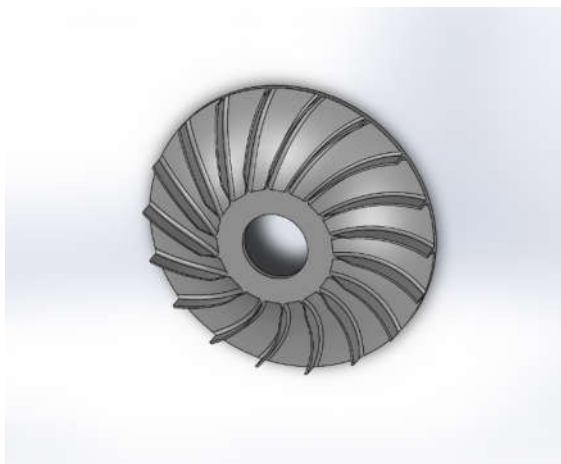

Figure 6. Backward Curved with 18 Blades

pressure drop causes the intake air flows to around the motor components. Then air directly discharges to atmosphere. For modeling rotation of rotary parts, multi (rotating) reference frames method used in calculations. So reference frames of the fluid around the rotary parts such as fan, rotor and rods set as rotating reference frames. No-slip boundary condition imposed on all walls.

The bearings haven't any directly contact with the critical components and also the cooling air doesn't pass over them, so their losses have no effect on the temperature distribution of the internal components, and these losses was neglected.

3. Solution Method

Based on Reynolds law, much of the fluid flow regime especially around the motor fan is turbulent. So equations of k- ϵ turbulence model added to domain equations.

The turbulence kinetic energy, k , is the kinetic energy per unit mass of the turbulent fluctuations u_i' in a turbulent flow. In order to determining of turbulence kinetic energy often used from equation (1):

$$k = \frac{1}{2} (\overline{(u'_1)^2} + \overline{(u'_2)^2} + \overline{(u'_3)^2}) \quad (1)$$

Turbulence dissipation rate, ϵ , is the rate at which turbulence kinetic energy is converted into thermal internal energy. Formulation of turbulence dissipation rate for compressible flows usually used in following form:

$$\epsilon \equiv \frac{1}{\rho} \tau_{ij} \frac{\partial u_i}{\partial x_j} \quad (2)$$

As convergence criteria, criteria of less than 10^{-4} was used for residuals of continuity, momentum and turbulence equations and also criteria of less than 10^{-6} was used for residuals of energy equation.

4. Results and Discussion

4.1. Validation

Discussed motor is equipped with a radial blade fan with 18 numbers of blades. As mentioned earlier, this category of motors are dividing to various working classes based on their operating temperature. The motor is placing in a working class with operating temperature of 135 to 195°C [12]. With the

4.2. Results

Contours of temperature distribution are shown in Figures 8-11. As it is obvious in the figures in all of fan types, the end windings have maximum temperature but the amounts of them are different for each fan. When cooling air passes through motor and reaches to end coils, it is preheated and has least temperature difference with end coils hence, heat exchanging between end coil and cooling air is reduced. For this reason coils have the maximum temperature in all simulations, end coils have maximum temperature and rotary rods of rotor beside of cooling air inlet channel have minimum temperature

Details of maximum temperature, mass flow rates, forces and moments for each type of fan are shown in table 2. As shown in table 2, mass flow rate of fans is a function of the

Table 2. Important Results of Fans

Number	Type	Max. Temperature (°C)	Mass Flow Rate (kg/sec)	Moment (N. m)	Windage Loss (kW)
1	Radial Blade- 18 Blades	168.5	0.186477486	17.10	2.685
2	Radial Blade- 12 Blades	164.6	0.226028676	16.01	2.514
3	Backward curved- 18 Blades	166.1	0.18955452	11.96	1.879
4	Backward curved- 12 Blades	161.8	0.18565191	11.61	1.823

aim of validating simulation results, at first step, the accuracy of simulations investigated by comparing temperature of motor components while equipped the reference fan with working class requirements. As it seems in Figure 8, when cooling fan is reference fan, end windings have maximum temperature with 168°C and it's in the range of working classes requirements. So the simulation results are in the range required and experimental data confirm the numerical results. So performance specifications of this type of motors such as temperature distribution, torques of rotary parts and cooling air velocity can be predicted with CFD simulations. Afterward the simulation continues by changing in the fan geometry.

blades quantity and for any type of fan has an ideal amount and this ideal amount is different for each shape of fan blade. For radial blade type, fan with 12 blades has more mass flow rate, while backward curved fan has more mass flow rate with 18 blades.

As mentioned in Table 2, fan with backward curved blade type and with 12 quantities of blades has least maximum temperature and also least mass flow rate. This fan in comparison to other fans has less resistance torque and less windage losses.

In Figures 12-15, vectors of air velocity are shown. Velocity profiles, turbulence and concentration of air of inside the motor have direct influence on the motor components temperature.

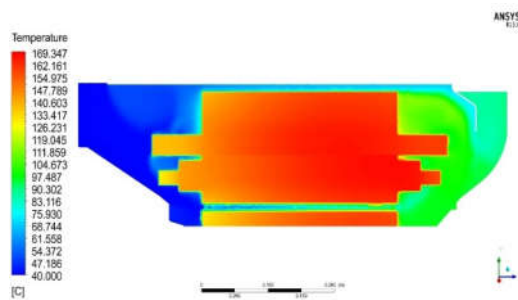

Figure 8. Radial Blade with 18 Blades

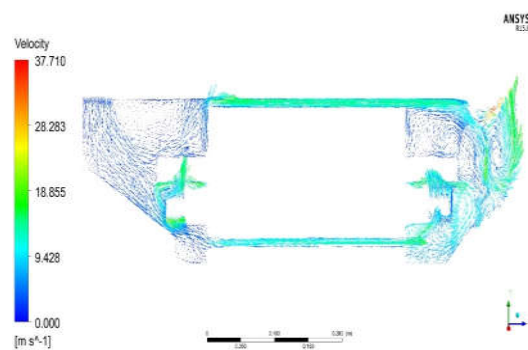

Figure 12. Radial Blade with 18 Blades

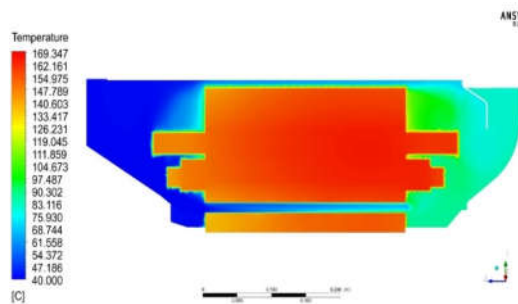

Figure 9. Radial Blade with 12 Blades

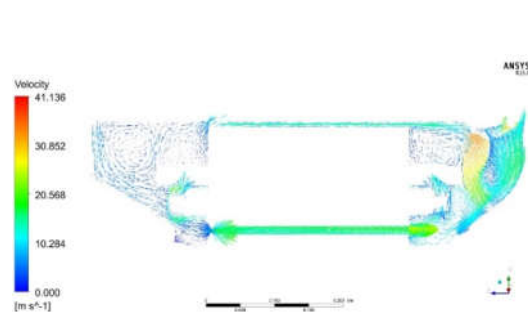

Figure 13. Radial Blade with 12 Blades

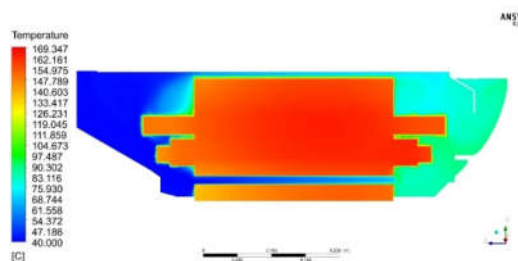

Figure 10. Backward Curved with 18 Blades

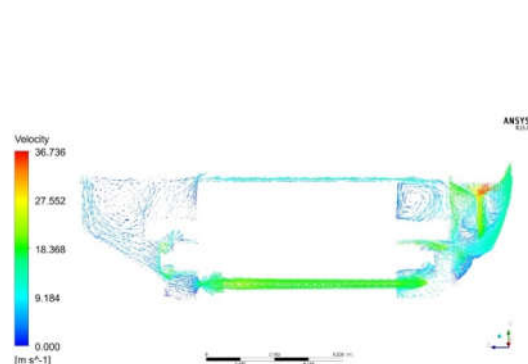

Figure 14. Backward Curved with 18 Blades

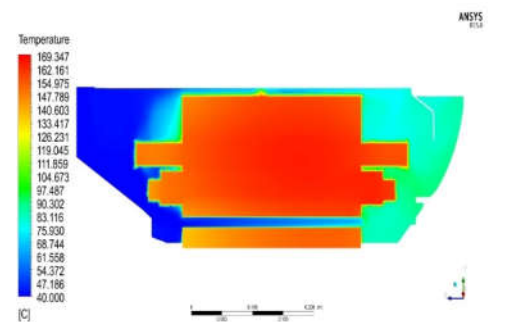

Figure 11. Backward Curved with 12 Blades

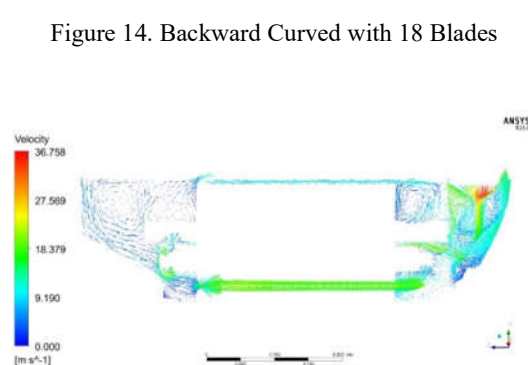

Figure 15. Backward Curved with 12 Blades

As it's clear in the figures, velocity patterns have differences in terms of concentration, velocity direction and magnitude of air for various blade shapes. This difference becomes more severe near the fans. However, this variation is petty for fans with same blade shape and various blade quantities.

5. Conclusions

Computational fluid dynamic simulation of traction motor is performed in order to optimize geometry of cooling fan. Four different fans with various blade types and different number of blades are used in simulations. Based on the simulation results, motor with 12 blades backward curved fan has least temperature in comparison to other cases specially reference fan. So in term of avoidance from overheating, operating temperature of the motor will remain in a more safe range. In this situation, due to lower operating temperature, electrical resistance and losses will be reduced and the motor life time will be increased. In term of windage losses, this fan has a minimum viscous and pressure resistance and this means minimum windage losses. Accordingly, this fan leads to power increase and maximum efficiency.

As mentioned earlier, manufacturing cost is very important for this type of fans. It is worth mentioning that the radial blade fan could be built with conventional casting methods, while the backward curved fan will need a more expensive manufacturing process such as investment casting or CNC machining.

The 12 blades backward curved fan has less losses and more efficiency but has more cost. Due to increasing motor life time and efficiency, its high price in the long term is negligible and admissible.

References

[1] A. Boglietti, A. Cavagnino, D.A. Staton, Thermal analysis of TEFC induction motors, presented at the Industry Applications Conference, 2004.

[2] W.F. Arcier, L. Serillon, Thermal modeling of permanent magnet motor for traction, Master, KTH Royal Institute of Technology, 2007.

[3] K. James, H. Pyung, Optimizing heat sink geometry for electric vehicle BLDC motor using CFD, IEEE, (2009), pp.194-195.

[4] C.C. Chang, Y.F. Kuo, J.C. Wang, S.L. Chen, Air cooling for a large-scale motor, Applied Thermal Engineering, Vol.30, (2010), pp.1360-1368.

[5] W. Li, J. Cao, X. Zhang, Electrothermal analysis of induction motor with compound cage rotor used for PHEV, IEEE Transactions on Industrial Electronics, Vol.57, No.2, (2010), pp.660-668.

[6] P. Hwang, J. Kuria, Estimation of bearing frictional losses of electric vehicle motor system, presented at the Korean Society of Tribologists and Lubrication Engineers (KSTLE), Seoul, S. Korea, 2010.

[7] K.Y. Kim, S.J. Seo, Application of numerical optimization technique to design of forward-curved blades centrifugal fan, JSME International Journal, Vol.49, No.1, (2006), pp.152-158.

[8] X.Z. LI, Fluent-based numerical simulation of flow centrifugal fan, Journal of Coal Science & Engineering, Vol.17, (2011), pp.198-200.

[9] T. Sun, Y. Li, Y. XXu, Z.Y. Wang, Numerical simulation and optimization of centrifugal fan, Advances in Mechanical and Electronic Engineering Journal, LNEE 176, (2012), pp.311-315.

[10] Y.T. Lee, V. Ahuja, A. Hosangadi, M.E. Slipper, P. Lawrence Mulvihill, R. Birkbeck, R.M. Coleman, Impeller design of a centrifugal fan with blade optimization, International Journal of Rotating Machinery, Vol.2011, (2011), pp.198-200.

[11] F.P. Bleier, Fan Handbook, McGraw Hill, 1997.

[12] IEC, IEC 60349-2, ed. 3.0, International Electro technical Commission, 2010.