



## Controlling Train Power Consumption with Energy Storage Based on Fuzzy Control - Case Study on Line 3 of Tehran Metro

Mohammad Ali Sandidzadeh<sup>1\*</sup>, Tofiqh Faizy<sup>1</sup>, Farzaad Soleymani<sup>1</sup>

<sup>1</sup>School of Railway Engineering, Iran University of Science & Technology

### ARTICLE INFO

#### Article history:

Received: 28.01.2019

Accepted: 25.03.2019

Published: 15.06.2019

#### Keywords:

Electric Railway

Energy Storage System

Fuzzy Control Strategy

Super Capacitors

Energy Consumption

### ABSTRACT

New high-speed trains need modern energy management methods to reduce energy consumption. In this research, a fuzzy based control method is proposed to solve this problem. The results are evaluated on the basis of data from Line 3 of Tehran Metro network. Recovering the maximum amount of train kinetic energy when it is in the braking mode and optimal conditioning of traction systems demand between energy storage system and power supply network, are the fundamentals of control strategy. In the control strategy the reference values of voltage and current of super capacitors (storage system) are calculated according to storage system state of charge and actual speed of train as optimal set points. The results from the modelling and simulations demonstrate that after applying the control strategy, optimization of energy consumption, optimal DC link voltage regulation and significant reduction in line peak current and power are achieved.

## 1. Introduction

The increase in population in recent years has contributed to the progressive development of public transportation systems, trolley buses, trams, and light rail systems. Several factors, including the expansion of the rail network and the drop in voltage and energy losses, have led to many efforts to solve this problem. The energy losses of the components of the transportation systems are high and the energy consumption of the entire system are obtained by collecting the waste of its sub-sections. Hence, a new energy management method based on modern management approaches to minimize this waste of energy in transportation systems is needed [1]. New energy management techniques are available to control torque and reduce energy dissipation in motors through a new generation of electronic converters. In today's systems, due to the absence of bidirectional converters, electrical energy is lost in the resistors. With the

use of new energy management methods, energy storage through these methods should be planned to restore and provide energy.

Although the new energy management and control method can be used only when a train is in the acceleration mode while another train is simultaneously in the braking mode. The traffic conditions of rail lines that are not foreseeable are a very important factor in energy storage. The researchers' findings indicate that the maximum energy storage in accelerating mode can be up to ten percent [2]. Inverting substations is one of the researchers' proposed solutions to save energy for solving this problem [3-5].

The realization of this method imposes a lot of costs and forces us to make fundamental changes to the existing system architecture. Therefore, saving energy using the appropriate tools and using the modern management system in terms of energy and costs is a very reasonable method. [6-8].

\*Corresponding author

Email address: Sandidzadeh@iust.ac.ir

The energy storage devices that are mainly used for railway applications are electrochemical batteries, flywheels, electric double layer capacitors (EDLCs). Some researchers have introduced the concept of hybrid energy storages, which combine more than one storage technology to exploit at the best the advantages given by each storage device. These energy storage devices have different purchase and maintenance costs and many differences exist in terms of functionality and performance, too. One of the factors to be taken into consideration is that the frequency of charge and discharge of energy storage devices has a significant impact on their lifetime. That's why it's a good idea to use super capacitors to solve this problem [9]. Energy storage in rail transport systems is generally performed by using wayside storages or storage networks in stations or mobile storages that in most cases it is installed on the roof of the train [10]. Each of the sub-sections saves energy independently, and finally all the energy is accumulated in the energy storage system but wayside and stationary storage devices as their name imply, are installed stationary and along the lines, respectively. Each system has its own advantages and disadvantages. Both Siemens and Bombardier companies are currently using this method [11].

Many non-railway projects have involved with energy storage in electrical equipment. There have been reasonable concerns for research in this area, as well. However, regarding energy storage only few projects were conducted in the rail transport systems. Because of the amount of the torque and the running speed of the motor in the rail transport industry that are vastly different from the other industries, the existing control methods that are used in many industries cannot be utilized in the railway sector [12].

Additionally, research on energy storage in various industries have not properly addressed the energy management issues. As a result, it cannot be stated that the available control methods can also be used in the railway industry.

In this research, the method of modern energy management is combined with the control strategies in the industry. The idea is to save energy and transfer it back to the network as much as possible.

The Fuzzy Control strategy is applied in this research to achieve the following selection of objectives:

1. Recover the maximum amount of kinetic energy during braking by train brake recovery technology
2. Optimum partition of Traction Systems power demand between application storage system and power supply network

In this control strategy the reference values of voltage and current of super capacitors (storage system) are calculated according to the state of charge of the storage system and the actual speed of the train.

The Fuzzy control strategy determines the maximum amount of the energy storage based on the train's speed and storage system state of charge to supply the traction system power. Since the load power demand (traction system inverter) is specified, the remaining required power for inverter traction will be supplied through the line by specifying the maximum storage requirement.

After designing and modeling the system, the simulation is carried out in Tehran metro line 3 to verify and check for the legitimacy of the results.

## 2. System Arrangement

Generally, the supply of train energy in interurban networks is through the overhead networks and is carried out through the metro via the third rail.

### 2.1. Electrical Traction Drive

Nowadays, with the recent advances in the design and implementation of traction systems, all types of tractions including AC or DC types with any range of voltages can be provided. The choice for the type of traction in a rail network depends on the homemade decisions and the available local standards. The Electric transmission lines for trains in rail networks are usually provided by one of two types of 0.75 kV or 1.5 kV DC systems. These two types are economically viable.

Figure 1 presents the power system and the typical electrical drive configuration on high-speed trains in metro lines. The energy storage system is also presented.

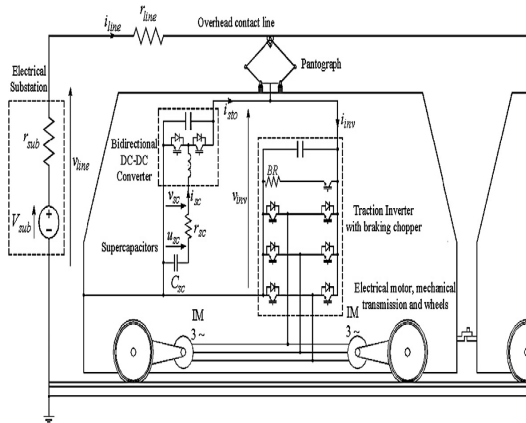

Figure 1. Typical electrical drive configuration [9]

The Electrical multiple unit trains (EMU) are also surveyed in this research. It needs to be noted that this system is currently in use on Tehran Metro Line 3. The train gross weight is used for the calculations. With the inclusion of six engines and 2 wagons in the train makeup the train gross weight adds up to 408 tons. The maximum train speed is set at  $v_t = 80 \text{ km/h}$ . The maximum train acceleration rate is  $a = 1 \text{ m/s}^2$  and the maximum braking deceleration rate is  $d = 1.2 \text{ m/s}^2$ .

Each engine in the train makeup consists of asynchronous induction motors, whose energies are supplied by three-phase inverters. All inductive motors work on the same bogie.

The rail vehicle axles are driven by the corresponding induction motors through transmission systems that are mounted underneath the vehicles. The power supply voltage is 750V and the size of the rail resistance per kilometer is at  $5.6 \frac{\text{m}\Omega}{\text{km}}$ .

## 2.2. Energy Storage System

The energy storage systems are installed onboard the trains. These systems depend on the super capacitors and the number of power supply system inverters.

For the purposes of this research, the energy storage system contains six inverters. In other words, each one of the energy storage systems is connected to the inverter DC bus network by means of a DC to DC converter. When a high-speed train is in the braking mode, the kinetic energy is stored in the super capacitors that are embedded in the energy storage system. This

energy that is stored by the super capacitors will be used in the acceleration mode and this cycle will be continued.

## 3. System Modeling

For the system modeling and simulation all components including the load (train Inverter), lines, substations and storage system (Storage equipment and related DC-DC Converter) need to be included.

Modeling the electrical positions of the trains is performed by using their Thevenin equivalent circuit.

Assume  $v_{sub}$  to be the source voltage,  $v_{line}$  the line voltage,  $r_{line}$  the line variable resistance and  $i_{inv}$  the source current that supplied the inverters. At this stage the traction and the braking power can be calculated. By summing up these two terms of power with the power for the auxiliary equipment, the whole train inverter power; which can be a positive or negative is obtained.

$$i_{inv} = \frac{P_{inv}}{v_{inv}} \quad (1)$$

And the power drawn from the train or returned to the line is calculated according to the Equation (2).

$$P_{inv} = \left\{ \begin{array}{l} \frac{F_t v_t}{\eta_{el} \eta_{mech}} + P_{con} \quad , F_t > 0 \\ F_t v_t \eta_{el} \eta_{mech} + P_{con} \quad , F_t < 0 \end{array} \right\} \quad (2)$$

Where,  $v_t$  is the actual train speed,  $F_t$  total is the traction effort,  $\eta_{el} = \eta_{em} \eta_{inv}$  is the electrical efficiency,  $\eta_{mech}$  is the mechanical efficiency and  $P_{con}$  indicates the required power for the other auxiliary equipment (ventilation, lighting, heating).

Figure 2 presents the behavior of the torque against the angular speed for a single traction motor. From this figure the parameter  $P_{inv}$  while considering  $(T_{m,v}, \omega_{m,v})$  can be obtained.

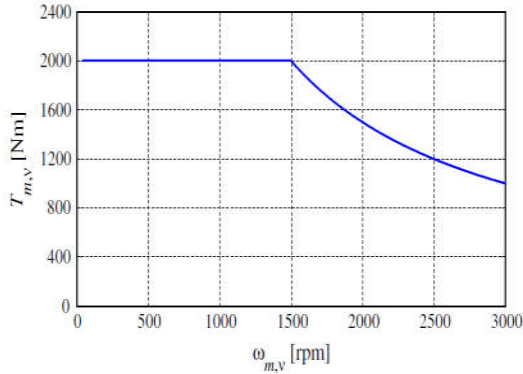

Figure 2. Torque against angular speed for a single traction motor [9]

Following on:

$$\begin{aligned}
 V_{sub} - (r_{sub} + r_{line})i_{line} &= v_{inv} \\
 r_{line} &= \frac{Rx_t}{L} \\
 i_{line} &= i_{inv} - i_{sto} \\
 i_{inv} &= \frac{P_{inv}}{v_{inv}} \\
 i_{sto} &= \frac{v_{sc} i_{sc,ref}}{v_{inv}} (\eta_{dc} )^{sgn(F_t)}
 \end{aligned} \tag{3}$$

$$\begin{aligned}
 i_{sc,ref} &= -(c_0 + 2c_1 u_{sc}) \frac{du_{sc}}{dt} \\
 v_{sc} &= -r_{sc} i_{sc,ref} + u_{sc} \\
 u_{sc}(0) &= V_{sc,max}
 \end{aligned}$$

$$\begin{aligned}
 F_t - F_r &= (m_t + m_{sc}) \frac{dv_t}{dt} \\
 \frac{dx_t}{dt} &= v_t \\
 F_r &= a + bv_t + cv_t^2
 \end{aligned} \tag{4}$$

Taking into account that  $N_m$  is the number of the traction motors,  $R_{wheel}$  the radius of the driven wheel,  $\tau$  the transmission ratio,  $T_{m,v}$  is the torque of the  $v$ th traction motor and  $\omega_{m,v}$  is the angular speed of the wheels.

#### 4. Fuzzy Control Strategy Design for Energy Storage System

Fuzzy control strategy determines the super capacitors (storage) maximum power for supply traction system power due to the actual speed of the train and the storage system state of charge. The control strategy block diagram is presented in Figure 3.

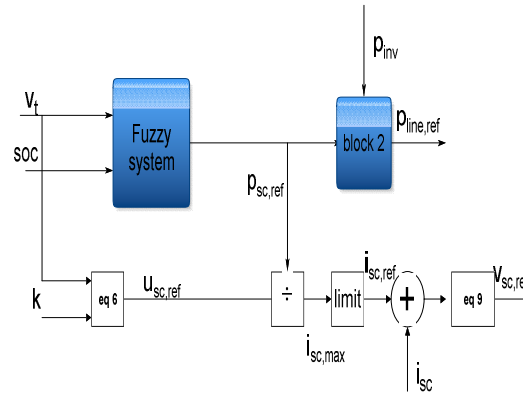

Figure 3. Control strategy block diagram

Due to the specified load (the traction system inverter) power demand, with specifies the maximum storage system power inverter traction, the remaining required power will be supplied through the line.

It should be noted that the train speed  $v_t$  can be measured by using an encoder that can be mounted on the engine shaft. The first step in any fuzzy system is the fuzzification of the inputs by the fuzzificator.

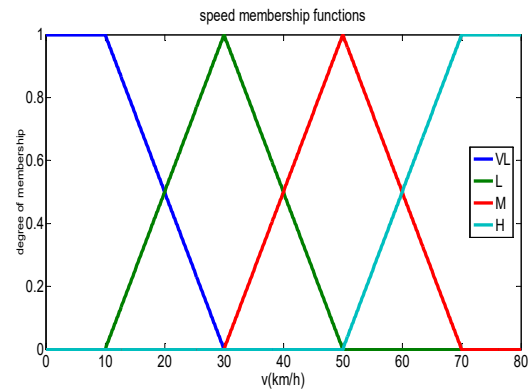

Figure 4. Fuzzy speed membership functions

The Fuzzificators that are used in this research paper are the triangular and the trapezoidal types.

Initially, it is needed to define the Membership functions input for the

fuzzification. The Fuzzy system membership functions are presented in Figures 4 and 5.

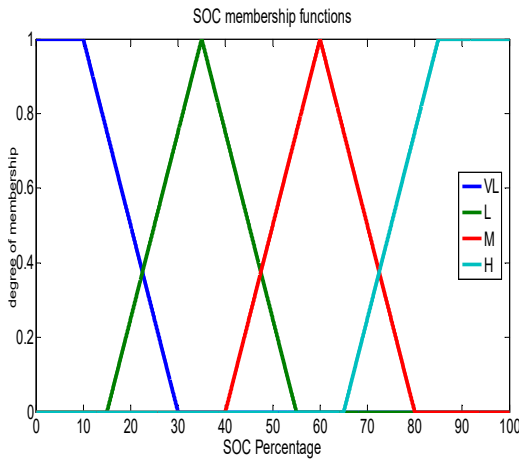

Figure 5. Fuzzy state of charge membership functions

The Fuzzy output membership functions that are the super capacitors reference power are presented in Figure 6.

In order to insert the super capacitors in the proper operating conditions, the reference values of the voltage and the current set-point of the super capacitors (storage system) need to be defined.

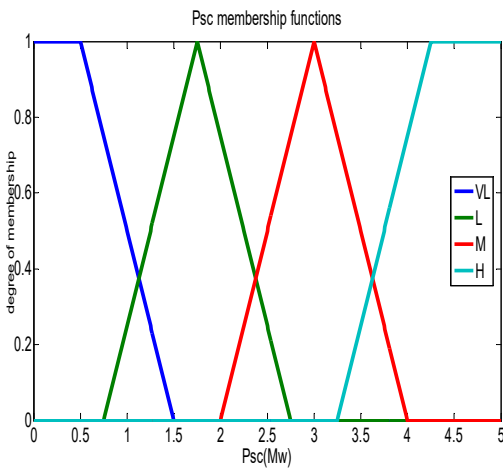

Figure 6. Fuzzy output membership functions

At this stage, the set-point can be find by using the super capacitors reference power. Prior to this, the super capacitor reference voltage need to be set.

Table 1. SOC According to  $v_t$

SOC/ $v_t$	VL	L	M	H
VL	VL	VL	L	L
L	VL	L	L	M
M	VL	L	M	M
H	VL	M	M	H

The basis for the energy saving is the brake energy recovery. The energy that is stored in the super capacitors from the initial voltage  $u_{sc}(0) = V_{sc,max}$  to its final voltage charge is calculated as follows:

$$E_{sc} = \frac{1}{2}c_0(V_{sc,max}^2 - u_{sc}^2) + \frac{2}{3}c_1(V_{sc,max}^3 - u_{sc}^3) \quad (5)$$

Due to the loss of the electrical energy, only a portion of the kinetic energy can be saved by the energy saving super capacitors. Hence, the following equations can be written:

$$\frac{1}{2}c_0(V_{sc,max}^2 - u_{sc,ref}^2) + \frac{2}{3}c_1(V_{sc,max}^3 - u_{sc,ref}^3) = \frac{1}{2}k \left( m_t + \frac{E_{sc,max}}{\alpha} \right) v_t^2 \quad (6)$$

Where  $m_t$  indicates the weight of the train.

From the mathematical model, the super capacitors output power can be calculated as in Equation (7):

$$P_{sc} = v_{sc} i_{sc} \quad (7)$$

Then the super capacitor current set-point is given by the following Equation (8):

$$i_{sc,ref} = \frac{P_{sc,ref}}{u_{sc,ref}} \quad (8)$$

To obtain a super capacitor reference voltage, the super capacitors current reference are compared with the actual current and the resulting error is processed by using a PI regulator. It will then result in  $v_{sc,ref}$  according to the following Equation (9):

$$v_{sc,ref} = k_p (i_{sc,ref} - i_{sc}) + k_i \int (i_{sc,ref} - i_{sc}) dt \quad (9)$$

By using Equation (9) the signal parameter  $\rho$  that is the PWM block duty cycle can be calculated according to Equation (10):

$$\rho = 2\left(\frac{v_{sc} - v_{sc,ref}}{v_{inv}}\right) - 1 \quad (10)$$

In case when the upper switch is set to position ON, the signal  $\rho$  is set to 1. When the lower switch is set to position ON, the signal  $\rho$  is equal to -1.

### 5. Numerical Results

After running the simulation model the results are presented in Table 2. These results indicate that the control method that is used is appropriate. It can be used for the energy storage system on trains in the rail transport network.

Table 2. Simulation data parameters

Simulation parameters	
Train arrangement	Six motor car and two trailer car
The empty train average mass	274000kg
Full load train average mass	408000kg
Motor car average mass	37500kg
Trailer car average mass	31000kg
Axles number connected to the motors in motor cars	4
Number of applied brake force axles	24 axle dynamic brake, 32 axle pneumatic brake
Train length	Less than 157.36m
Maximum train speed	80km/h
Maximum positive grab the moment	1m/s <sup>2</sup>
Maximum negative grab the moment	1.2m/s <sup>2</sup>
Traction operating voltage range	680v
Line rated voltage	750v
Line maximum current	6500A
Third rail material	Aluminum - Steel

Third rail electrical resistance per unit of length	5.6 mΩ/km at 20 ° C
track rail electrical resistance per unit of length	31 mΩ/km at 20 ° C
Line voltage range	500-900v
Auxiliary systems average power	500kw

It should be noted that the simulated model based on the previous sections of this article is implemented and tested on the existing system in Line 3 of Tehran Metro. The energy storage system is the stationary super capacitor.

The results indicate that using this method for managing energy through fuzzy technique is effective. It can also be used in other rail networks.

As a case study, running a train between two stations in Line 3 of Tehran Metro is investigated. The track profile for this case study included:

The length of the first station (code A3-5): 220 meters without track gradient.

The length of the second station (code A3-6): 220 meters without track gradient.

The distance between the two stations: 1310 meters with a track gradient of 27/1000.

The speed profile that is used for the simulation along the route between the two stations is based on the actual data and is presented in Figure 7. The total running time for the process is equal to 175 s. The acceleration process is from time  $t = 0$  till time  $t = 45s$ .

From  $t=45s$  to  $t=150s$  the train travels at a constant speed. At  $t=150s$  the train braking starts. The braking lasts for 25 seconds before the train stops. The maximum train speed in this process is 14.45m/s (52km/h).

Figure 8 presents the distance traveled by the train during the simulation. For the purposes of the simulation, the distance between the centers of the two stations is used and is equal to 1530m.

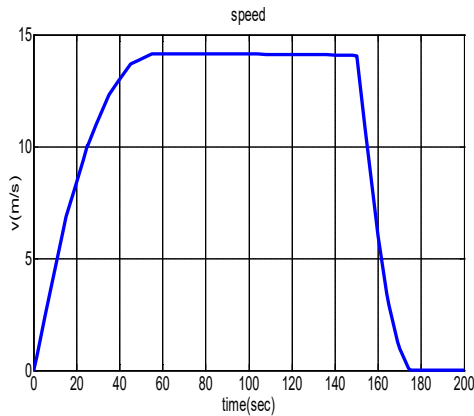

Figure 7. Output membership functions

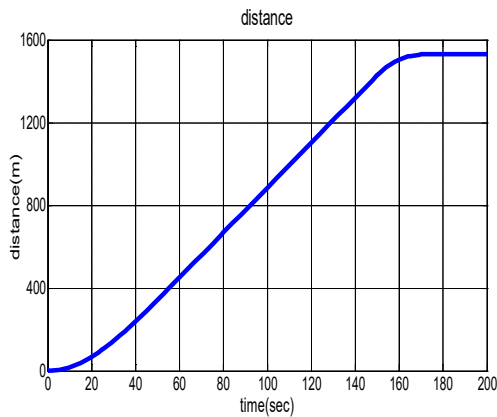

Figure 8. Distance between the two stations

In the following, outputs for the electrical terms out of the simulation are discussed. The energy storage system performance must be such that in train acceleration it can supply the partial power demand of the traction system. While the DC link voltage regulation prevents voltage drop and prevents high line current consumption. In brake mode this system must recover and save the maximum recovered brake energy. It must also prevent the DC link voltage increases. The Metro system schematic with storage equipment has been shown in Fig 9.

The maximum current in the traction system appears during the acceleration times that in this case is equal to  $t = 25s$  here. At this instant the inverter required a current of 8.15kA to supply the traction system. Part of this current equal to 3kA comes from the supply line and the storage system provides the remaining 5.15kA. It is assumed that the storage system has the maximum initial charge. As presented in Figure 10, at  $t = 60s$  the storage system reached its

minimum charge, due to the governing conditions. From this moment the line supply total inverter current requirement is 5.46kA. At braking time  $t = 150s$  the maximum storage system recovery current is 12.9kA. The initial outcome of the installation of the storage control system is the reduction in the maximum line current.

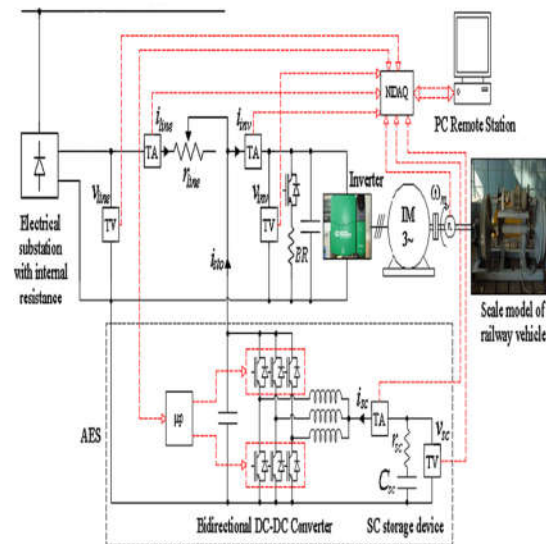

Figure 9. Train Schematic with power storage devices [9]

The inverter current (power) at each instant is extracted from the line and the storage system current (power). The inverter, line and storage system current waveforms are presented in Figure 10.

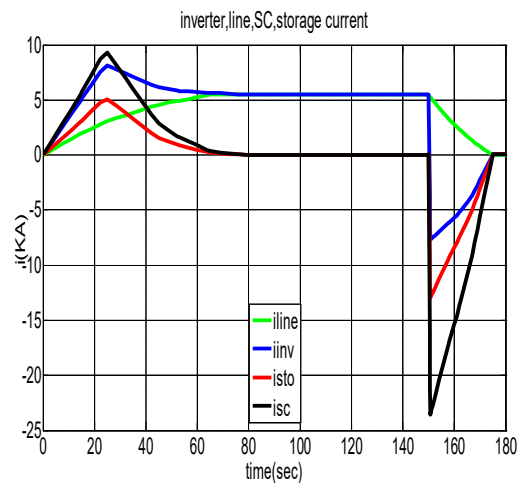

Figure 10. Inverter, line, storage system and SC current

Another important point that is presented in Figure 10 is that the line current at the braking is reduced to zero. At this instant the line current is not null. This current is to overcome the resistance forces. From Figure 10 it should be noted that the storage system current is bidirectional. It's DC-DC converter current and is different from the super capacitors current. The super capacitor current is presented with the black color curve in Figure 10. To detect the current for each super capacitor module one needs to consider that:

The maximum super capacitor current of 23.55 kA must be provided by 54 parallel modules. Therefore, the current for each module is  $i_{sc} = \frac{23550}{54} = 436.11A$ .

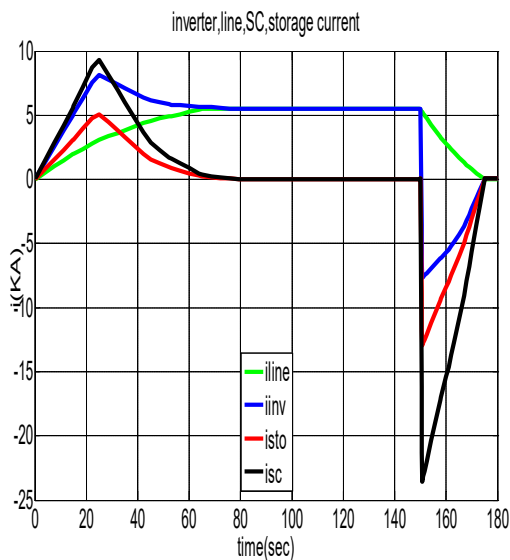

Figure 11. Inverter, traction motor, line, storage system and SC power

The estimated power at different sections including the traction motor, inverter, main line, storage system and super capacitor are presented in Figure 11. The inverter maximum power is at 6.3 Megawatts. The storage system supplies 3.5Mw of it and the main line supplies the remaining. The power at the super capacitors and the storage sets are equal. This is due to the fact that the bidirectional DC-DC converter by the same proportion that reduces the super capacitor current increases the super capacitor voltage. It is also noticeable that there is inequality for power between the traction system and the inverter. This is due to the power required by the auxiliary equipment such as the ventilation, lighting, heating and cooling systems. There is

also power losses in the system that need to be accounted for.

The energy flow diagram of the rail system is presented in Fig 12. From this the flow and the energy conversion and losses of various sectors is evident. The voltages at different system sections are analyzed. The super capacitor internal voltage that is calculated based on Equation (9) is presented in Figure 12.

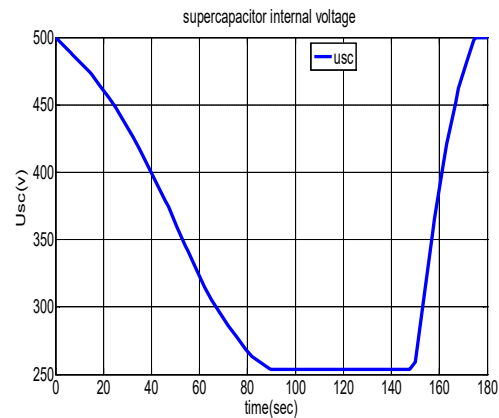

Figure 12. Super capacitor internal voltage

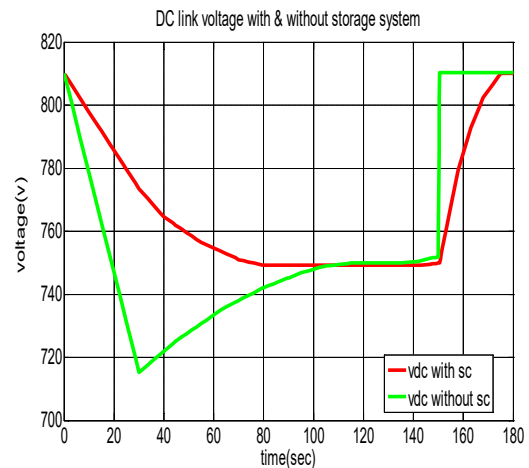

Figure 13. DC voltage with and without storage system

The super capacitors are discharged through DC to DC converters. There is also the possibility for the SOC to reach somewhere between the rated voltage value of  $v_{sc,max} = 500v$  and its half.

During the acceleration process the super capacitor voltage increases and at deceleration it charges to  $v_{sc,max} = 500v$ .



One of the advantages of the installation and control of the storage system is the DC link voltage regulation. For a better realization in the application of this system, the DC link voltage with and without the storage system are compared in Figure 13.

Without the storage system the DC link voltage drops from 810V (no load) to 716V during the acceleration process. This is equal to 11.6% voltage drop. But with the storage system the voltage drop reduced to 7% (from 810V to 750V). This can be interpreted as 4.6% improvement in the DC link voltage drop. Figure 14 compares the main line current with and without the storage system.

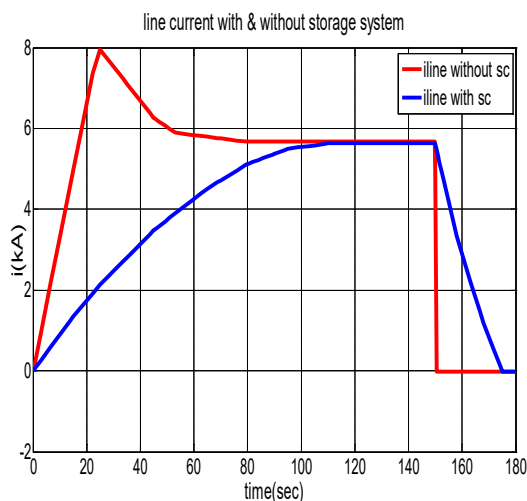

Figure 14. Line current with and without storage system

From Figure 14 it is concluded that the line peak current reduces from 8kA at  $t = 25s$  to 5.56kA. A significant reduction of 32%. The line peak current reduction not only reduces the energy consumption but also improves the basic parameters for the main line and substation design.

The energy consumption is also amongst the terms in focus. The purpose of the energy storage is to be able to recover and store the rail vehicle kinetic energy during its braking processes. The consumed and the supplied energy by various sections including the inverter traction energy, the traction motor energy (also known as the mechanical energy) and the main supply line and the storage system energy are presented in Figure 15.

The following points can be extracted from the information in Figure 15.

1. At  $t = 150s$  that is the braking start point, the traction inverter required energy is 190kwh. The storage system supplies 32kwh and the main line supplies 158kwh. This means that the storage system supplies 16.84% and the main line supplies 83.16% of the total energy requirement for the traction inverter. With the storage system the energy saving is 16.84%.
2. The storage system energy diagram is proportional to the square of the train speed.
3. The storage system energy at the end of the motion cycle is equal to zero. This means that the storage system charges during the braking and discharges during the accelerating times.

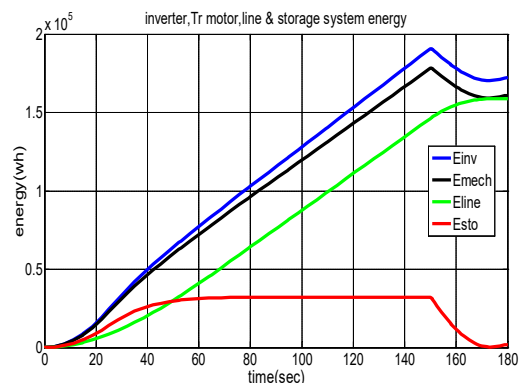

Figure 15. Inverter, traction motor, line and storage system energy

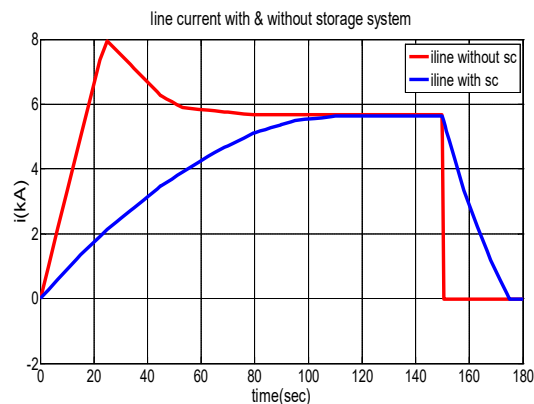

Figure 16. Line energy with and without the storage system

The estimated main supply line energy with and without the storage system are compared at Figure 16. Without the energy storage system the main line is needed to supply all inverters energy requirements that is equal to  $190kwh$  . With the storage system the energy consumption from the main supply line reduces to  $158kwh$  .

All the above presented results involved the first and the second stations of the Line 3 of Tehran Metro network. In a further endeavor and on the basis of the same type of modelling, a variety of simulations were performed for a train running between some other stations in Tehran Metro network. The results are presented in Table 3.

the traction system power. The modelling and simulations performed on the Line 3 of Tehran metro network trains demonstrated that with the proper energy storage system installation and control, energy consumption reduction of 35% is achievable.

The usage of the energy storage systems on the trains have some other added advantages. Amongst them are up to 35% reduction in the main supply line peak current and power consumption that improves the basic parameters of the main line and the substation designs. It also regulates the DC link voltage to a significant percentage. In this case, without the storage system the DC link voltage drop is 11.6% but with the storage system the voltage drop is 7%.

Table 3. The results of various simulations for a train running between different stations on Tehran Metro network

Origin station	Destination station	gradient (Per mill)	Optimization of energy consumption (Percent)	Line peak current Reduction (Percent)
A3-6	A3-5	1.96	16.84	32
A3-5	A3-4	2.74	19.69	35
A3-4	A3-3	2.9	20	31
A3	B3	-1.15	18.71	31
G3	H3	49.6	18.83	33
N3	O3	-31.02	35.71	32

Table 3 (continued). The results of various simulations for a train running between different stations on Tehran Metro network

Origin station	Destination station	inverter			Storage system			line		
		$I_{max}$ kA	$P_{max}$ Mw	$E_{max}$ kwh	$I_{max}$ kA	$P_{max}$ Mw	$E_{max}$ kwh	$I_{max}$ kA	$P_{max}$ Mw	$E_{max}$ kwh
A3-6	A3-5	8.15	6.3	190	5.15	3.15	32	5.46	4.2	158
A3-5	A3-4	8.67	6.85	198	5.2	3.25	39	5.64	4.44	159
A3-4	A3-3	8.74	6.93	205	5.22	3.3	41	5.82	4.63	164
A3	B3	7.75	6.02	187	5.11	3.09	35	5.33	4.13	152
G3	H3	9.31	7.43	223	5.87	4.05	42	6.14	5.12	181
N3	O3	7.47	5.63	154	5.6	3.96	55	5.33	5.23	99

## 6. Conclusions

This research presented the fuzzy control strategy for energy management of metro trains that are equipped with the super capacitor energy storage system. Due to the actual running speed of the train and the storage system state of charge, the fuzzy control strategy determines the super capacitors maximum power for supplying

The power storage system also enhances the system reliability.

## References

- [1] Siemens, Sitras SES, Stationary energy storage system for DC traction power supply [Online], (Nov. 2012), Available:

<http://www.mobility.siemens.com/ts/de/pub/404.htm>

[2] B. Mellitt, Z.S. Mouneimne, C.J. Goodman, Simulation study of DC transit systems with inverting substations, *IEE Proceedings B Electric Power Application*, 131(2), (1984), pp. 38–50.

[3] Ch. Bae, D.U. Jang, Y.G. Kim, Calculation of regenerative energy in DC 1500V electric railway substations, In: *Proc. of 7th Int. Conf. Power Electron. ICPE'07*, Daegu, South Korea, October 22–26, (2007), pp. 801–805.

[4] V. Gelman, Braking energy recuperation, *IEEE Vehicular Technology Magazine*, 4(3), (2009), pp. 82–89.

[5] C.H. Park, S.J. Jang, B.K. Lee, C.Y. Won, H.M. Lee, Design and control algorithm research of active regenerative bidirectional DC/DC converter used in electric railway, In *Proc. 7th Int. Conf. Power Electron. ICPE'07*, Daegu, South Korea, October 22–26, (2007), pp. 790–794.

[6] Y. Taguchi, M. Ogasa, H. Hata, H. Iijima, S. Ohtsuyama, Simulation results of novel energy storage equipment series-connected to the traction inverter, In: *Proc. 12th Eur. Conf. Power Electron. and Applicat. EPE'07*, Aalborg, Denmark, September 11–14, (2007), pp. 1–10.

[7] D. Iannuzzi, P. Tricoli, Metro trains equipped onboard with supercapacitors: a control technique for energy saving, In: *Proc. Int. Symp. Power Electron. Elect. Drives, Automation and Motion, SPEEDAM'10*, Pisa, Italy, June 14–16, (2010), pp. 750–756.

[8] M. Miyatake, H. Haga, Optimization of speed profile and quick charging of a catenary free train with on-board energy storage, In: *Proc. Int. Conf. Elect.Syst. for Aircraft, Railway and Ship Propulsion ESARS'10*, Bologna, Italy, October 19–21, (2010), pp. 1–6.

[9] D. Iannuzzi, F. Ciccirelli, D. Lauria, Stationary ultracapacitors storage device for improving energy saving and voltage profile of light transportation networks, *Transportation Research Part C: Emerging Technologies*, 21(1), (2012), pp. 321–337.

[10] Overview of braking energy recovery technologies in the public transport field, Ticket to Kyoto, WP2B. Deliv.1  
<http://www.tickettokyoto.eu/sites/default/files/d>

[download/file/T2K\\_WP2B\\_deliverable1\\_20110520.pdf](download/file/T2K_WP2B_deliverable1_20110520.pdf)

[11] M. Steiner, M. Klohr, S. Pagiela, Energy storage system with ultracaps on board of railway vehicles, in *Proc. 12th Eur. Conf. Power Electron. Appl. (EPE 2007)*, Aalborg, Denmark, Sep. 11–14, pp. 1–10.

[12] P. Grbovic, P. Delarue, P.L. Moigne, P. Bartholomeus, The ultra-capacitor based controlled electric drives with braking and ride-through capability: overview and analysis, *IEEE Transaction on Industry Electronics*, 58(3), (2011), pp. 925–936.